

Shimadzu Analytical Balance Instruction Manual

AUW-D series **AUW220D, AUW120D**
AUW series **AUW320, AUW220, AUW120**
AUX series **AUX320, AUX220, AUX120**
AUY series **AUY220, AUY120**

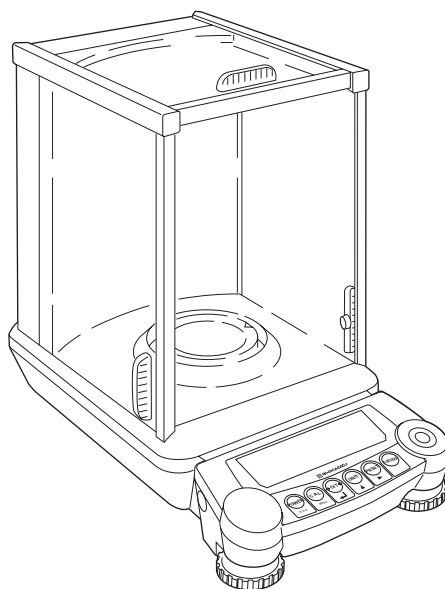

Read the instruction manual thoroughly before you use the product.
Keep this instruction manual for future reference.

 **SHIMADZU CORPORATION**
KYOTO JAPAN

ANALYTICAL & MEASURING INSTRUMENTS DIVISION



Requests

- Provide this manual to the next user in the event that the instrument is transferred.
- To ensure safe operation, contact your Shimadzu Balance representative for installation, adjustment, or reinstallation after moving the instrument to a different site.

Notices

- The content of this manual is subject, without notice, to modifications for the sake of improvement.
- Every effort has been made to ensure that the content of this manual was correct at the time of creation. However, in the event that any mistakes or omissions are discovered, it may not be possible to correct them immediately.
- The copyright of this manual is owned by Shimadzu Corporation. Reproduction and duplication of whole or part of the content without permission of the company are strictly prohibited.
- "Microsoft", "Windows", and "Excel" are registered trademarks of Microsoft Corporation of the U.S.A. in the United States and other countries. All other company names and product names that appear in this manual are trademarks or registered trademarks of the companies concerned. Note that ™ and ® indications are not used.
- The company names, organization names and product names in this manual are trademarks or registered trademarks of the companies and organizations concerned.
- Shimadzu does not guarantee that the WindowsDirect communication function will operate without problems on all PCs. Shimadzu will accept no responsibility for any trouble that arises as a result of using this function. You are recommended to back up all important data and programs in advance.

© 2003-2013 Shimadzu Corporation. All rights reserved.

Notation Conventions



Note

This instruction manual uses the following notation conventions to indicate Safety Precautions and additional information.



Caution

Indicates a potentially hazardous situation that may result in injury to personnel or equipment damage.



Note

Provides additional information needed to properly use the balance.



Other conventions used in this manual include:

Item	Description
1, 2, 3 ...	Indicates the step number in a procedure or a sequence of changes in the balance display.
[] key	Indicates the operation key on the balance. See 2.2 .
“ ”	Indicates the message appearing in the balance display.
mass display	Indicates that the balance is in the weighing mode and mass is displayed in one of the weighing units.



Safety Precautions To be strictly observed





To ensure that you use the balance safely and correctly, read the following precautions carefully and observe them.

The levels of danger and damage that will arise if the balance is used incorrectly are classified and indicated as shown below.

 WARNING	Indicates a potentially hazardous situation which, if not avoided, could result in serious injury or possibly death.	 CAUTION	Indicates a potentially hazardous situation which, if not avoided, may result in minor to moderate injury or equipment damage.
--	--	--	--

Precautions are classified and explained by using one of the symbols below, depending on the nature of the precaution.

 Instructions	Indicates an action that must be performed.	 Prohibitions	Indicates an action that must NOT be performed.
---	---	---	---

 WARNING	
 Prohibitions	<p>Never disassemble, modify or attempt to repair this product or any accessory.</p> <p>You could sustain an electric shock or the product could operate abnormally. If you believe that the balance has failed, contact your Shimadzu representative.</p>
 Instructions	<p>Use the balance with correct power supply and voltage.</p> <p>Use the balance with the attached AC adapter.</p> <p>Using the balance with an incorrect power supply or voltage will lead to fire or trouble with the balance. Note also that if the power supply or voltage is unstable or if the power supply capacity is insufficient, it will not be possible to obtain satisfactory performance from the balance.</p>
 Instructions	<p>Use the correct weighing units.</p> <p>Using incorrect weighing units can lead to accidents as a result of weighing errors. Check that the weighing units are correct before starting weighing.</p>
 Prohibitions	<p>Do not use the balance outdoors or anywhere where it will be exposed to water.</p> <p>You could sustain an electric shock or the product could operate abnormally.</p>

⚠ CAUTION



Prohibitions

Avoid locations where the balance will be exposed to any of the following.

- This could cause accidents or poor performance.
- Air flow from an air conditioner, ventilator, door or window
 - Extreme temperature changes
 - Vibration
 - Direct sunlight
 - Corrosive or flammable gases
 - Dust, electromagnetic waves or a magnetic field

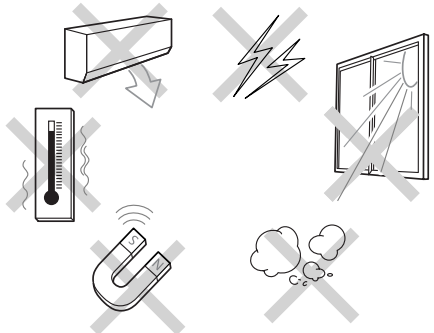

Instructions

Install the balance on a strong and stable flat table or floor in the room.

Placing the balance in an unstable site could lead to injury or trouble with the balance. When selecting the installation site, take into account the combined weight of the balance and the item to be weighed.



Instructions

After a power outage, turn the power back ON.

When a power outage occurs, the power is shut off automatically. Therefore, begin operation from 4.4 "Turning On the Power" (🔌 page 12) again.



Instructions

Treat the balance with care and respect.

The balance is a precision instrument. Subjecting it to impacts could cause it to fail. When moving the balance, remove pan and pan supporter. Grasp it firmly with both hands to carry it. If the balance has to be stored for a long time, store it in the packaging box in which it was delivered.



Prohibitions

Do not connect anything other than peripheral devices specified by Shimadzu to the balance's connector.

If you do, the balance may stop working normally. In order to avoid trouble, always connect peripheral devices in accordance with the directions in this manual.



Instructions

If you detect anything abnormal (e.g. a burning smell) disconnect the AC adapter immediately.

Continuing to use the balance with an abnormality could lead to fire or an electric shock.

Shimadzu Balances and 21 CFR Part 11

21 CFR Part 11

21 CFR Part 11, Electronic Records, Electronic Signatures, Final Rule (often referred to as Part 11) is the United States Food and Drug Administration (FDA) regulation affecting computer resources and electronic records that are used for any document that is required to be kept and maintained by FDA regulations.

Requirements concerning computer resources security are key elements in Part 11.

The controls implemented as a result of security related requirements are intended to result in trusted records.

Shimadzu CLASS-Balance Agent

Shimadzu provides a means for compliance with 21 CFR Part 11 with Shimadzu CLASS-Balance Agent software, part of a comprehensive laboratory data management system, Shimadzu CLASS Agent.

Ask your Shimadzu representative about it.

Shimadzu WindowsDirect

When Shimadzu balances are integrated with laboratory software by means of our WindowsDirect function, no communication software is required or used.

The Shimadzu balance functions as a primary device in the system, just as a keyboard, mouse or other data entry hardware does.

For this reason, system validation and compliance may be greatly simplified with the use of Shimadzu balances.

Two-way Communication

Shimadzu balances have always been computer friendly and they can be set up for bi-directional communication as part of a fully automated production system or LIMS.

This manual includes the command codes and information needed by programmers to integrate Shimadzu balances with their software.

Action for Environment (WEEE)

To all user of Shimadzu equipment in the European Union:

Equipment marked with this symbol indicates that it was sold on or after 13th August 2005, which means it should not be disposed of with general household waste. Note that our equipment is for industrial/professional use only.

Contact Shimadzu service representative when the equipment has reached the end of its life.

They will advise you regarding the equipment take-back.

With your co-operation we are aiming to reduce contamination from waste electronic and electrical equipment and preserve natural resource through re-use and recycling.

Do not hesitate to ask Shimadzu service representative, if you require further information.

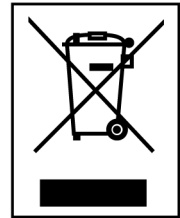

WEEE Mark

Contents

1. Introduction	1
2. Component Names and Functions	2
2.1 Main Components	2
2.2 Key Panel and Operation	3
2.3 Balance Display and Functions	4
3. Specifications	5
4. Installation	7
4.1 Installation Site	7
4.2 Unpacking and Delivery Inspection	8
4.3 Installation	10
4.4 Turning On the Power	12
4.5 Span Calibration	13
5. Basic Operation (Read Chapters 1 to 5 for basic but proper operation of the balance.)	15
5.1 Weighing	15
5.2 Changing the Unit Display	17
5.3 Switching the Weighing Range (AUW-D series only)	17
5.4 For Stable Measurement in Semi-micro Range (AUW-D series only)	18
6. WindowsDirect Function	20
6.1 What is WindowsDirect?	20
6.2 WindowsDirect Settings	20
6.2.1 Setting the Balance	20
6.2.2 Connecting the RS-232C Cable	21
6.2.3 Setting Up the Computer	22
6.2.4 Start and Checking Operation	24
6.3 Troubleshooting the WindowsDirect Communication Function	25
7. Menu Item Selection	27
7.1 What is a menu?	27
7.2 What is a menu map?	27
7.3 Menu Item Selection Procedures	28
7.4 Useful Functions Related to Menu	30
7.4.1 Settings Check Display	30
7.4.2 Returning to Default Settings (Menu reset)	30
7.4.3 Menu Lock	31

8. Setting the Built-in Clock (AUW-D/AUW/AUX series only)	32
8.1 Date	32
8.2 Date Output Style	33
8.3 Time	34
9. Display Settings	35
9.1 Bar Graph Display	35
9.2 Changing the Minimum Display (AUW/AUX/AUY series only)	36
9.3 Turning the Backlight On and Off (AUW series only) (Not for AUW-D)	37
10. Calibration	38
10.1 What is calibration?	38
10.1.1 The Necessity of Calibration	38
10.1.2 Types of Calibration	39
10.2 Executing Calibration	40
10.2.1 Span Calibration With Built-in Weight (AUW-D/AUW/AUX series only)	40
10.2.2 Span Calibration With External Weights	41
10.2.3 Calibration Check With Built-in Weight (AUW-D/AUW/AUX series only)	42
10.2.4 Calibration Check With External Weights	43
10.3 Calibration Settings	44
10.3.1 Selecting Preset Calibration Method	44
10.3.2 PSC Fully-automatic span calibration (AUW-D/AUW/AUX series only)	45
10.3.3 Clock-CAL Fully-automatic span calibration (AUW-D/AUW series only)	47
10.3.4 PCAL: Calibration of the Built-in Weight (AUW-D/AUW/AUX series only) ..	49
10.3.5 Inputting External Calibration Weight Value for E-CAL	50
10.3.6 Inputting External Calibration Weight Value for PCAL	51
10.4 For GLP/GMP/ISO Compliance	52
10.4.1 Calibration Report Setting	52
10.4.2 Balance ID Setting	53
10.4.3 Date Printout Setting	54
11. Environment Settings	55
11.1 What are environmental settings?	55
11.2 Settings for Stability and Response	55
11.2.1 Standard mode	55
11.2.2 Anti-convection mode	55
11.2.3 High-stability Mode	56
11.2.4 Pouring Mode (fast response)	56
11.3 Stability Detection Band	58
11.4 Zero Tracking	59
11.5 Stability Mark Lighting Timing	60

12. Units	61
12.1 Setting Units of Measurement	61
12.2 Percentage (%) Conversion	63
13. Application Functions	64
13.1 Piece Counting (PCS)	64
13.2 Solid Specific Gravity Measurement	65
13.3 Liquid Density Measurement	68
13.4 Auto Print	71
13.5 Interval Timer (AUW-D/AUW/AUX series only)	72
13.6 Add-on Mode	74
13.7 Formulation Mode	77
14. Communication with Peripheral Devices	79
14.1 Electronic Printer EP-80	79
14.2 Personal Computer - RS-232C	80
14.2.1 Connecting the Cable	80
14.2.2 Data Format	81
14.2.3 Command Codes	83
14.3 Communication Settings	85
14.3.1 What are communication settings?	85
14.3.2 Standard Setting	85
14.3.3 User Setting	86
14.4 Decimal Point Symbol in Output Data	89
15. Maintenance and Transport	90
15.1 Maintenance	90
15.2 Transport	92
16. Troubleshooting	93
16.1 Error Code Displays	93
16.2 Troubleshooting	94
Appendices	95
A-1. Menu map	95
A-2. Standard Accessories and Maintenance Parts List	98
A-3. Special Accessories (Options) List	98
A-4. Specifications for RS-232C Connector	99
A-5. Table of Unit Conversion Constants	100
A-6. Performance Check Guide	101
A-7. Below-weigh Hook Dimensions	103
A-8. Index	104

1. Introduction

Thank you for choosing the Shimadzu AUW-D/AUW/AUX/AUY Series analytical balance. Shimadzu confidently offers this high-performance analytical balance, the result of over 90 years of experience in manufacturing precision balances. While providing rapid and accurate mass measurement, reliability has been improved even more by employing the UniBloc cell, introduced for use in electronic balances by Shimadzu in 1989. These Shimadzu analytical balances provide WindowsDirect functions for transfer of measurement results to personal computer without installing software. This and other various functions can be used to meet the operator's objectives. Also, the AUW-D/AUW/AUX series offers consistently accurate measurement without calibration work, with temperature detection and time setting, and the built-in motor-driven calibration weight that performs fully-automatic span calibration.

In order to make full use of the functions and performance provided in the AUW-D/AUW/AUX/AUY series balance, please read this instruction manual before using the balance and keep the manual for future reference.

For information on the following points, please contact your Shimadzu Balance representative.

- Product warranty
- After service

This manual has notation for AUW-D series, AUW series, AUX series, AUY series, combined as AUW-D/AUW/AUX/AUY series (or notations two to three series). Note that the menu settings and the calibration display examples shown in this manual are mainly for the AUW220 model. On different models, the numerical values and other items may differ.

The model name can be found in the label placed in front of the weighing chamber. The alphabets in model name indicate its series name. AUW220D and AUW120D are called AUW-D series.

Symbols Used in the Manual

1,2,3 ...	Shows operation procedure.
[POWER] key, etc.	[] shows operation keys .
"E-CAL" etc.	Shows items displayed on the balance, including displays appearing during menu selection.
g display	The balance display is in gram unit so the value changes depending on the load on the pan.
Mass display	The balance display is in one of mass units so the value changes depending on the load on the pan.

2. Component Names and Functions

2.1 Main Components

Read these pages before installation

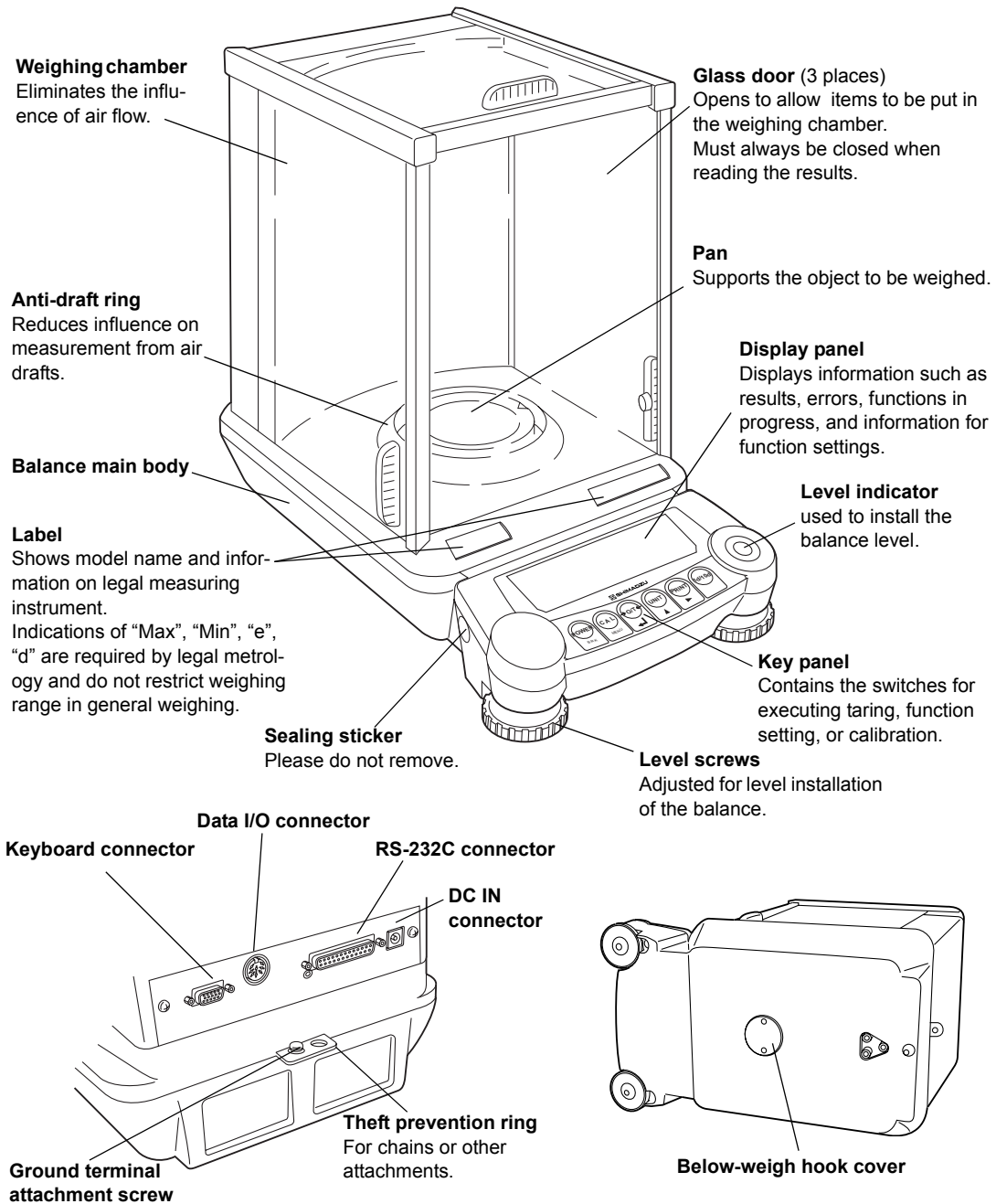

For Basic Operation

2.2 Key Panel and Operation

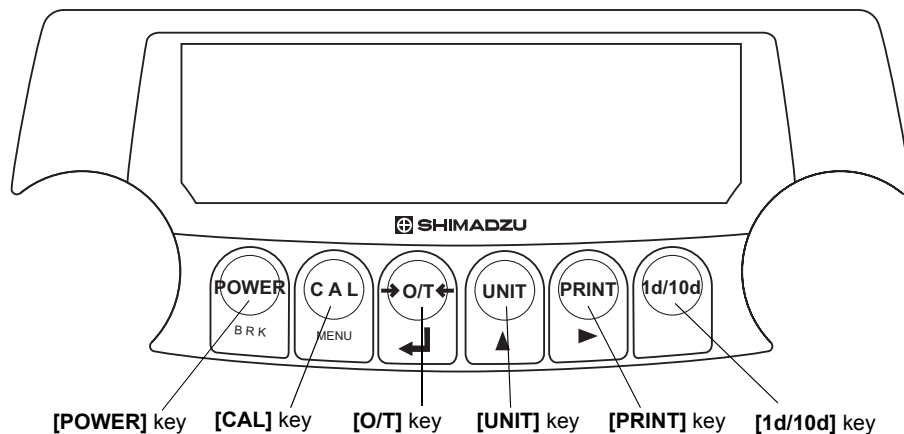

The following is a list of the functions for each key.

Key	During Measurement	
	Pressed once and released	Pressed and held for about 3 seconds
[POWER]	Switches between the operation and standby modes.	Switches the key notification buzzer on/off.
[CAL]	Enter calibration or menu item selection.	Enter calibration or menu item selection.
[O/T]	Tares the balance. (Displays zero.) *1	
[UNIT]	Switches the units of measurement.	
[PRINT]	Outputs the displayed values to an electronic printer, computer, or other external devices.*2	Outputs the date and time to external devices. (Not with AUJ)
[1d/10d]	AUW/AUX/AUJ	Switches display between 1d/10d. (Minimum display is rounded by one digit.) *3
	AUW-D	

*1 Either "Taring" (at a weight exceeding 2.0% of the capacity) or "Zero-setting" (at a weight within 2.0% of the capacity) takes place with a verified balance as a legal measuring instrument in EU.

*2 Output is not made until the display is stable with a verified balance as a legal measuring instrument in EU.

*3 Not applicable to a verified balance as a legal measuring instrument in EU.

Key	During Menu Item Selection	
	Pressed once and released	Pressed and held for about 3 seconds
[POWER]	Return to the menu above the current menu level.	Returns to mass display.
[CAL]	Moves to the next menu item.	
[O/T]	Select or set the displayed item, or enter into the displayed menu.	
[UNIT]	Numerical value input, increases the numeric value of the blinking digit by 1.	
[PRINT]	Numerical value input, moves the blinking digit.	
[1d/10d]	No effect.	

2.3 Balance Display and Functions

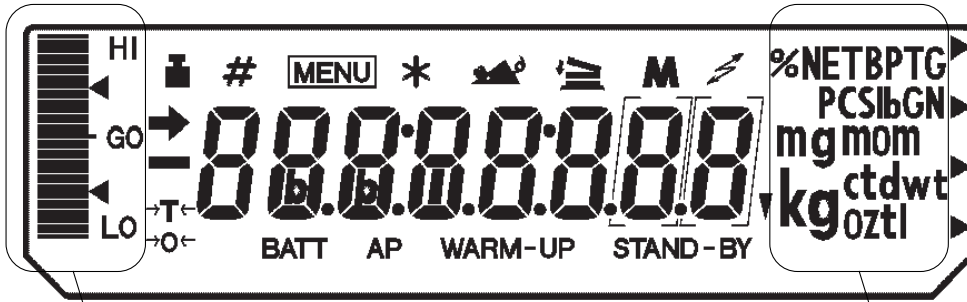

Bar graph display section

Units display section

(Some of the symbols and characters on the balance display are not used by this balance.)

Display	Name	Description
→	Stability mark	Indicates that the weighed value is stable. In menu selection, indicates the currently selected item.
↔	Tare symbol	Indicates that Taring has been made at over 2.0% of the capacity.
⊗	Zero symbol	Note: Using a verified balance as a legal measuring instrument in the EU: Indicates that the balance is set exactly to "Zero" with the zero-setting function (within $\pm 0.25e$: e = verification scale interval).
■	Weight symbol	Appears during span calibration. Blinks before automatic calibration starts. Blinks to advise necessity of span calibration.
[]	Bracket	Note: Using a verified balance as a legal measuring instrument in the EU: The figure(s) bordered by the bracket is(are) the auxiliary indicating device.
#	Number symbol	Indicates numeric value entry.
MENU	Menu symbol	Appears during menu selection. Always shown when the menu is locked.
⚙	Add-on symbol	Indicates set-up of Add-on mode or Formulation mode.
M	Memory symbol	Indicates set-up of Formulation mode.
⚡	Communication symbol	Indicates communication with external devices via RS-232C cable or Data I/O connector. Shown when communication functions are ON.
BATT	Battery symbol	Indicates a low battery voltage when using the balance with the optional battery pack.
AP	Auto Print symbol	Indicates set-up of the Auto Print function.
STAND-BY	Standby mark	Appears during standby status. Indicates standby of the interval timer output function.
▼	Inverse triangle	Illuminates as part of the solid specific gravity measurement display.

3. Specifications

Series name	AUW-D series (Dual range type)		AUW series			AUX Series			AUY series	
	AUW220D	AUW120D	AUW320	AUW220	AUW120	AUX 320	AUX220	AUX120	AUY220	AUY120
Model name	AUW220D	AUW120D	AUW320	AUW220	AUW120	AUX 320	AUX220	AUX120	AUY220	AUY120
Capacity	220g/82g	120g/42g	320g	220g	120g	320g	220g	120g	220g	120g
Minimum display	0.1mg/0.01mg	0.1mg/0.01mg	0.1mg	0.1mg	0.1mg	0.1mg	0.1mg	0.1mg	0.1mg	0.1mg
Repeatability (standard deviation σ)	≤ 0.1 mg (220g range) ≤ 0.05 mg (82g range)	≤ 0.1 mg (120g range) ≤ 0.02 mg (42g range)	≤ 0.15 mg	≤ 0.1 mg	≤ 0.1 mg	≤ 0.15 mg	≤ 0.1 mg	≤ 0.1 mg	≤ 0.1 mg	≤ 0.1 mg
Linearity	± 0.2 mg (220g range) ± 0.1 mg (82g range)	± 0.2 mg (120g range) ± 0.03 mg (42g range)	± 0.3 mg	± 0.2 mg	± 0.2 mg	± 0.3 mg	± 0.2 mg	± 0.2 mg	± 0.2 mg	± 0.2 mg
Response time (typical)	3s (220g range), 10s (82g range, Pouring mode)	3s (120g range), 10s (42g range, Pouring mode)	3 s							
Calibration weight	Built-in								None	
Operation temperature range	5 to 40 deg.C									
Temperature coefficient of sensitivity (10 to 30 deg.c)	± 2 ppm/deg.C (when PSC function is Off)								± 2 ppm/deg.C	
Sensitivity stability (10 to 30 deg.c)	± 2 ppm (when PSC function is On)									
Pan size	80mm dia Approx.									
Main body dimensions	220mm W X 330mm D X 310mm H									
Main body Weight	7kg Approx.									
Rated electric power supply	DC 12V, 1A									
Data I/O	RS-232C									
Pollution Degree	2									
Overvoltage Category	Category II									
Altitude	Up to 2000 m									
Installation Site	device may only used indoors									
AC adapter (primary)	AC 100-240 V, 400mA 50/60Hz									
F u n c t i o n	Display back-light			●	●	●				
	PSC automatic span calibration	●	●	●	●	●	●	●	●	
	Clock-CAL	●	●	●	●	●				
	Built-in clock	●	●	●	●	●	●	●	●	
	GLP/GMP/ISO calibration report	●	●	●	●	●	●	●	●	
	WindowsDirect	●	●	●	●	●	●	●	●	●
	Interval timer output	●	●	●	●	●	●	●	●	
	RS-232 C I/F	●	●	●	●	●	●	●	●	●
	Specific gravity measurement software, piece counting, % display, unit conversion	●	●	●	●	●	●	●	●	●
	Analog display	●	●	●	●	●	●	●	●	●
Battery (option)	●	●	●	●	●	●	●	●	●	

3. Specifications

ECTA series name		AUW-D series (dual range type)		AUW series			AUX series			AUY series	
Model name		AUW220D	AUW120D	AUW320	AUW220	AUW120	AUX320	AUX220	AUX120	AUY220	AUY120
g	Accuracy class	Ⓛ	Ⓛ	Ⓛ	Ⓛ	Ⓛ	Ⓛ	Ⓛ	Ⓛ	Ⓛ	Ⓛ
	Capacity	220g/82g	120g/42g	320g	220g	120g	320g	220g	120g	220g	120g
	Verification scale interval (e)	0.001g	0.001g	0.001g	0.001g	0.001g	0.001g	0.001g	0.001g	0.001g	0.001g
	Number of verification scale interval	220000	120000	320000	220000	120000	320000	220000	120000	220000	120000
	Scale interval (d)	0.0001g/ 0.00001g	0.0001g/ 0.00001g	0.0001g	0.0001g	0.0001g	0.0001g	0.0001g	0.0001g	0.0001g	0.0001g
	Range of use	0.001g to 220g	0.001g to 120g	0.01g to 320g	0.01g to 220g	0.01g to 120g	0.01g to 320g	0.01g to 220g	0.01g to 120g	0.01g to 220g	0.01g to 120g
	Tare range (by subtraction)	220g	120g	320g	220g	120g	320g	220g	120g	220g	120g
ct	Accuracy class	Ⓛ	Ⓛ	Ⓛ	Ⓛ	Ⓛ	Ⓛ	Ⓛ	Ⓛ	Ⓛ	Ⓛ
	Capacity	1100ct/410ct	600ct/210ct	1600ct	1100ct	600ct	1600ct	1100ct	600ct	1100ct	600ct
	Verification scale interval (e)	0.01ct	0.01ct	0.01ct	0.01ct	0.01ct	0.01ct	0.01ct	0.01ct	0.01ct	0.01ct
	Number of verification scale interval	110000	60000	160000	110000	60000	160000	110000	60000	110000	60000
	Scale interval (d)	0.001ct/ 0.0001ct	0.001ct/ 0.0001ct	0.001ct	0.001ct	0.001ct	0.001ct	0.001ct	0.001ct	0.001ct	0.001ct
	Range of use	0.01ct to 1100ct	0.01ct to 600ct	0.1ct to 1600ct	0.1ct to 1100ct	0.1ct to 600ct	0.1ct to 1600ct	0.1ct to 1100ct	0.1ct to 600ct	0.1ct to 1100ct	0.1ct to 600ct
	Tare range (by subtraction)	1100ct	600ct	1600ct	1100ct	600ct	1600ct	1100ct	600ct	1100ct	600ct
Calibration weight	Built-in								None		
Ambient operation temperature	10 to 30 deg.C										
Pan size	80mm dia approx.										
Main body dimensions	220mmW X 330mmD X 310mmH approx.										
Main body weight	7kg approx.										
Rated electric power supply	DC 12V, 1A										
Data I/O	RS-232C										
Pollution Degree	2										
Overvoltage Category	Category II										
Altitude	Up to 2000 m										
Installation Site	device may only used indoors										
AC adapter (primary)	AC 100-240 V, 400mA 50/60Hz										
F u n c t i o n	Display backlight			●	●	●					
	PSC automatic span calibration	●	●	●	●	●	●	●	●		
	Clock-CAL	●	●	●	●	●					
	Built-in clock	●	●	●	●	●	●	●	●		
	GLP/GMP/ISO calibration report	●	●	●	●	●	●	●	●		
	WindowsDirect	●	●	●	●	●	●	●	●	●	●
	RS-232C I/F	●	●	●	●	●	●	●	●	●	●
	Specific gravity measurement software, piece counting, % display	●	●	●	●	●	●	●	●	●	●
	Analog display	●	●	●	●	●	●	●	●	●	●

4. Installation

4.1 Installation Site

(1) Power Requirements

Select an installation site that is near a power source to allow the use of the attached AC adapter or a site where the special accessory battery pack can be properly used. Verify that the power voltage conforms to that indicated on the AC adapter.

(2) Installation site



Caution

The balance must be installed in a proper place to ensure safe and accurate measurement. Avoid the following types of sites.

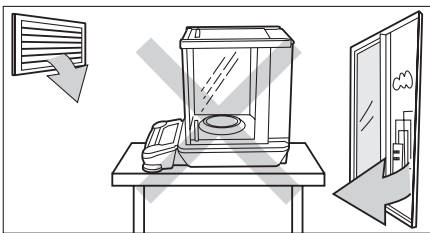

- Sites with air current from air conditioners, ventilators, open doors, or windows.

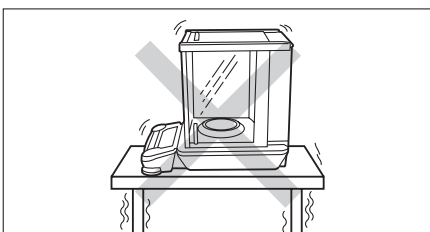

- Sites with vibration.

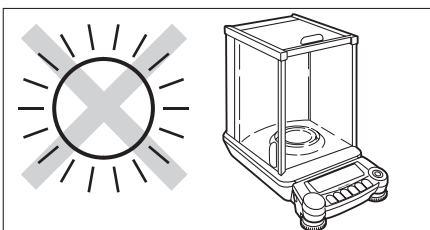

- Sites in direct sunlight.

(Continued)

4. Installation

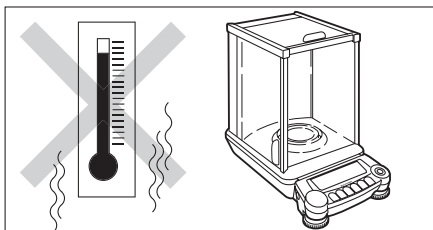

- Sites with extreme temperature changes, or high/low temperature, or high/low humidity.

- Sites near flammable or corrosive gases.
- Sites with dust, electromagnetic waves, or magnetic fields.

Install on a sturdy and level tabletop in the room. Stone is recommended. Rather than the middle of the room, the edges and corners are generally appropriate for vibration-free measurement.



Caution

The glass doors open backwards beyond the rear end of the main body. Make certain enough space is saved to allow the doors fully open.



Note

Using a verified balance as a legal measuring instrument in the EU:

The balance must be used within the temperature range indicated on the verification label.

4.2 Unpacking and Delivery Inspection



Caution

Analytical balance is a precision instrument. Make certain not to allow any impact when placing it on the table.

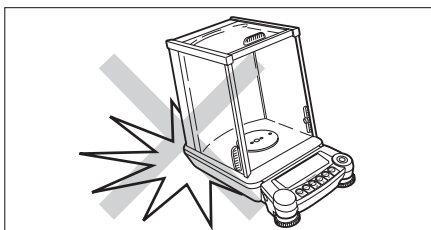

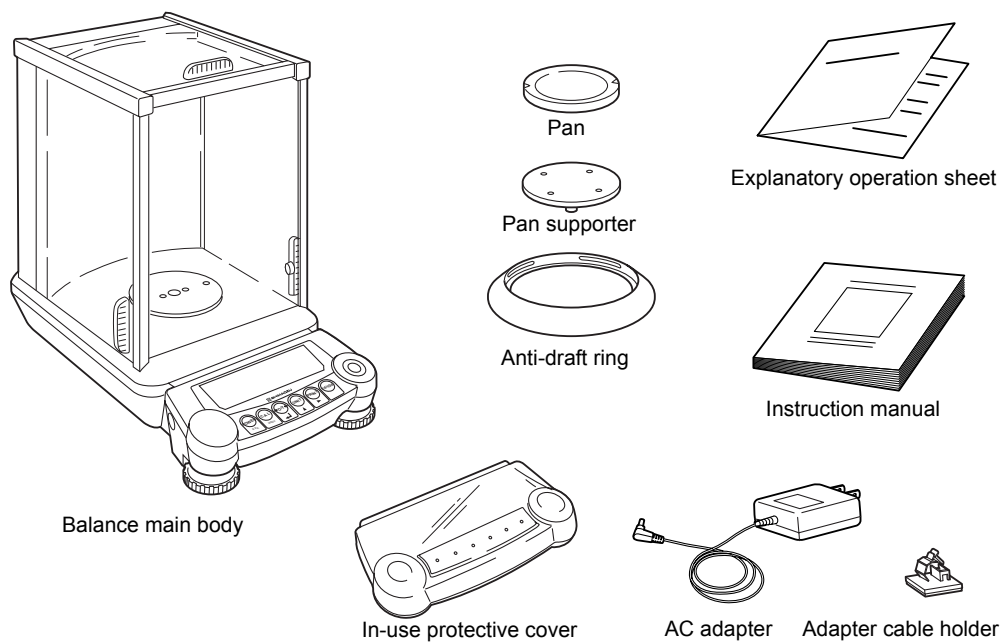

Verify that there has been no damage and that the following standard packing items are present. Contact your local distributor in case of damaged or missing items.

Standard packed items and quantity

Standard packed items	quantity
Balance main body	1
Pan	1
Pan supporter	1
Anti-draft ring	1
AC adapter	1
Adapter cable holder	1
Instruction manual	1
Explanatory operation sheet	1
Inspection certificate	1
In-use protective cover	1

4.3 Installation

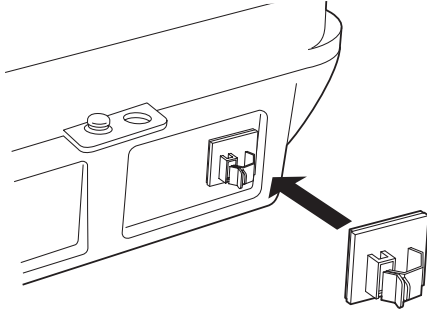

- 1** Attach the adapter cable holder.
Peel the protective sheet of adhesive off the adapter cable holder, and stick it on the back of the balance as shown in the figure.

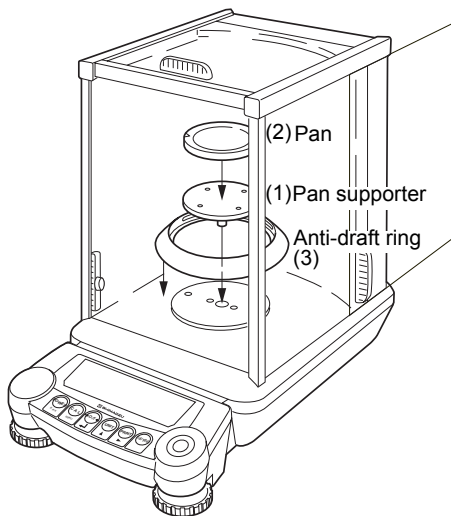

- 2** Place the balance main body on the installation site.

- 3** Attach the pan supporter, the pan, and the anti-draft ring.

- (1) Gently attach the pan supporter on the center axis of the weighing chamber.
- (2) Gently place the pan on the pan supporter.
- (3) Place the anti-draft ring.

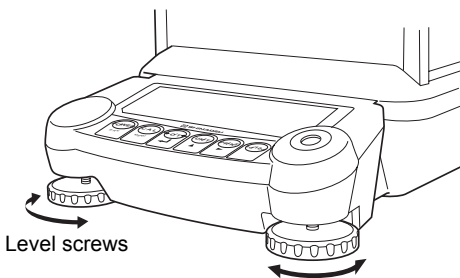

- 4** Adjust the horizontal level. (level adjustment)
There are two level screws on the front of this balance. The screws grow longer when turned in clockwise direction from above and they grow shorter when turned counter-clockwise. Adjust the level screws until the bubble in the level indicator is in the middle of the red circle.

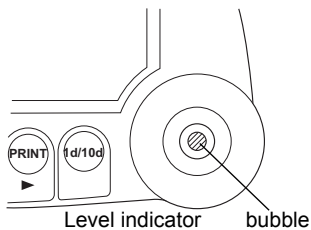

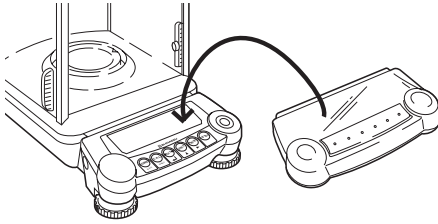

- 5** Attach the In-use protective cover. When the key panel and the display must be protected from dirt and wear, place the cover over the key panel.



Note

Using a verified balance as a legal measuring instrument in the EU:

Legal regulations require a verified balance be sealed. This control seal is a self-destructive adhesive label. This seal is irreparably damaged invalidating the verification, if you attempt to remove it. The balance must then be re-verified before it is used for legal measurements.

4.4 Turning On the Power

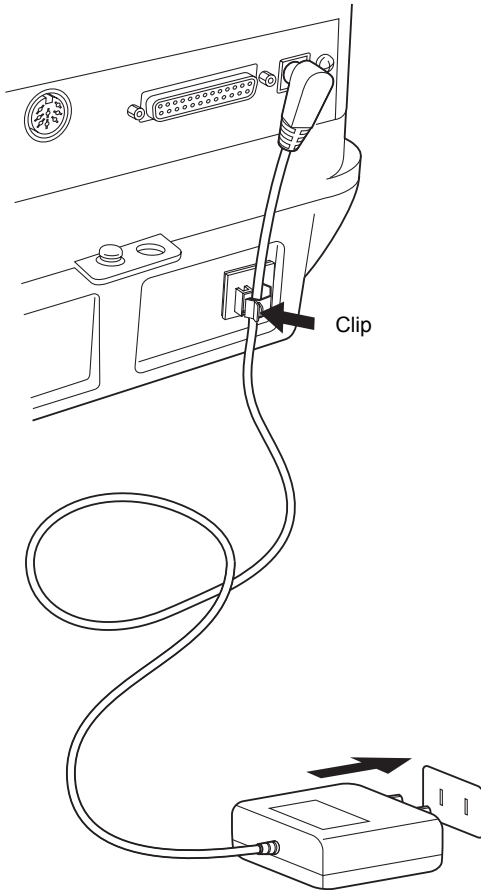

1 Insert the AC adapter plug in to the DC IN connector on the back of the balance. Place the AC adapter cable as shown in figure and hold it with the adapter cable holder.

2 Plug the AC adapter to the power outlet. After the balance performs a self check, calibration will be automatically executed. During this process, the display will change as follows. “CHE 5”, “CHE 4” “CHE 0”, “*.*.*.*”, “CAL 2”, “CAL 1”, “CAL 0”, “CALEnd”, “oFF” (This span calibration immediately after power up can be aborted by pressing the [POWER] key, however at least one span calibration is necessary before use. The AUY series does not perform calibration and the display showing “CAL...” will not appear.)
 “*.*.*.*” shows version number of software.



Note

A power cable may be necessary to connect the AC adapter to the power source, depending on the type of the AC adapter

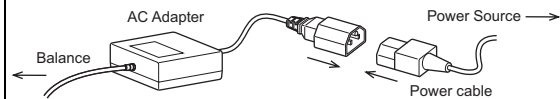

3 Press the [POWER] key. After all displays appear, the gram (g) display appears. Also, the display backlight illuminates (AUW series only).

4 Pressing the [POWER] key again turns on the standby symbol and puts the balance in standby (warm up) status. (For AUW-D/AUW/AUX series, the current time is displayed according to the built-in clock settings in 8. For the AUW series, the backlight will turn off.)

4.5 Span Calibration



Note

Using a verified balance as a legal measuring instrument in the EU:

Span calibration must be performed once the balance is installed and before using the balance as a legal measuring instrument in the EU. The balance must be connected to power and warmed up for at least one hour prior to span calibration and use as a legal measuring instrument.

When intending to use the AUW-D series in the small range (minimum display $d=0.01\text{mg}$), warm it up for at least four hours.

After installation, be certain to complete warm up and span calibration. During span calibration, the balance must be left in a very stable condition. To do this, leave the power on at standby (warm up) for an hour or more before performing calibration. When using the AUW-D series in the small range (minimum display 0.01mg), leave the power on for at least four hours. Also, perform calibration in conditions without people entering and leaving the room and without air flow or vibration. The AUW series is equipped with display backlight. Use of the backlight requires warm up in mass display such as "g", not in standby state. The default setting of backlight is ON.

For AUW-D/AUW/AUX Series (No operation is required)**Fully-automatic span calibration by PSC**

The default setting is ON for PSC, which performs fully-automatic span calibrations. When PSC is ON, span calibration is automatically performed, if necessary, when the gram display first appears after the balance is turned ON (See 4.4). When PSC operates, the weight symbol starts blinking about two minutes beforehand for notification. During operation, the display will automatically change and the motor sound of the weight loading system is heard. In order to ensure proper PSC operation, prevent vibrations and air flow. When gram display returns after completion of span calibration by PSC, measurement can begin according to 5. Basic Operation. (Fully-automatic span calibration by PSC is set to ON by default. Also, span calibration with built-in calibration weight is set as preset calibration method by default. For other methods, please refer to 10. Calibration. The AUW-D/AUW series also allow Clock-CAL function to perform span calibrations regularly by time settings.



Note

For accurate measurement, perform span calibration again when the balance is moved or when the temperature of the installation site has changed. It is recommended that either PSC or Clock-CAL be set to ON so that the necessary calibrations will operate automatically.

For AUJ Series**Span calibration with external weights**

- 1** Leave the pan with nothing on, in g display mode.
- 2** Press the [CAL] key once. "E-CAL" will be displayed.
- 3** Press the [O/T] key. The zero display will blink. Stability is confirmed after about 30 seconds and the value of the weight that should be loaded will blink.
- 4** Open the glass door, load the weights of the amount shown, and close the glass door of the weighing chamber.

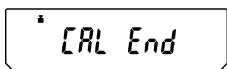
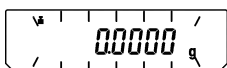
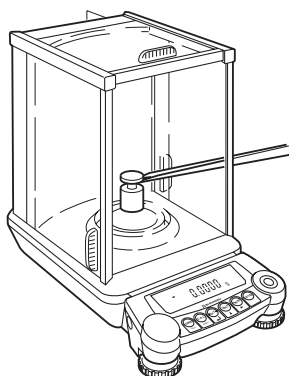
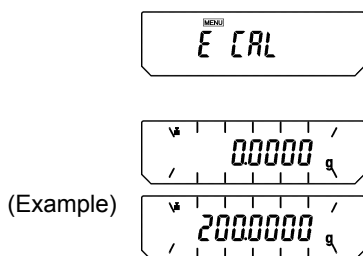

- 5** After a short time, the zero display will blink. Remove the weight from the pan and close the glass door. After "CAL End" appears, the display returns to g display mode and the calibration is complete.

Span calibration by external weights is set for routine calibration by default in AUJ series. For other methods, see [10. Calibration](#).

**Note**

For accurate measurement, perform calibration again when the balance is moved or when the temperature of the installation site has changed. Daily calibration before use is recommended.

5. Basic Operation

(Read Chapters 1 to 5 for basic but proper operation of the balance.)



Note

Before using the balance, warm up thoroughly (at least one hour) and calibrate. When intending to use the AUW-D series in the small range (minimum display 0.01mg), warm it up for at least four hours.

5.1 Weighing

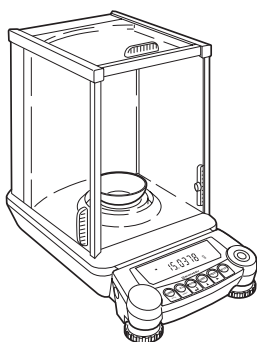

- 1** Open one of the glass doors of the weighing chamber, place the weighing vessel (container) on the pan, and close the glass door again. (When using a container)

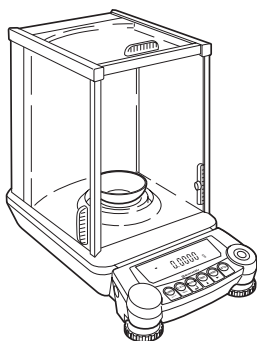

- 2** Wait for the display to stabilize and press the [O/T] key (taring). The appearance of the stability mark (→) indicates a stable state. The display will read zero.

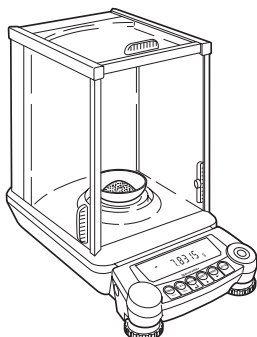

- 3** Open the glass door, place the items to be weighed in the weighing vessel and close the glass door.

- 4** After the display stabilizes, read the display.



Note

- Except when placing or removing items or calibration weights to and from the weighing chamber, keep the glass doors closed unless otherwise described in this manual.
- Air convection causes measurement error if the temperatures of the weighed item and the chamber are different. In order to avoid this, equalize the temperatures by leaving the item in the extra space within the chamber before weighing.



Notes

Using a verified balance as a legal measuring instrument in the EU:

 Indicates that the balance is set exactly to “Zero” with the zero-setting function (within $\pm 0.25e$: e = verification scale interval).

Using a verified balance as a legal measuring instrument in the EU:

The balance must be used within the temperature range indicated on the verification label.

When PSC (refer to [10.3.2](#)), fully-automatic span calibration, is not activated, operator must carry out span calibration (refer to [10.2](#)) upon blinking of the Weight Symbol.

5.2 Changing the Unit Display

Pressing the **[UNIT]** key switches display between the registered units, piece counting and specific gravity measurement modes. The units other than 'g', 'pcs', '%' and 'ct' are not registered in the default settings.



Note

The units to be used must be registered as described in 12.Units. If the power is turned off and turned on again, the weighing unit will be 'g'. (The registered units remain.)

5.3 Switching the Weighing Range (AUW-D series only)

In the dual-range balance AUW-D series, when the power is connected and turned on, the balance is set to the “small range” with a minimum display of 0.01mg. To switch to the “large range” with a minimum display of 0.1mg, press the **[1d/10d]** key (except for AUW-D series, this key has a different function. →9.2) . When measurement exceeds the small range capacity (82g for AUW220D, 42g for AUW120D) during use of the small range, display automatically switches to the large range. In this case, taring with **[O/T]** key in the large range will fix the range, and reducing the load on the pan within the small range capacity will not return it to the small range. **[O/T]** key has to be pressed again, within the small range, to resume the small range display.

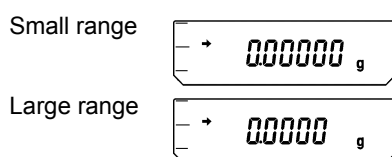

5.4 For Stable Measurement in Semi-micro Range (AUW-D series only)

The small range (semi-micro range, minimum display 0.01mg) of AUW-D series dual range balances produces excellent response and stability. However, weighing in the 0.01mg range is generally more subject to the environment and how measurements are performed compared to the 0.1mg range. When using the small range of AUW-D series, observe the following instructions in order to obtain the best result.

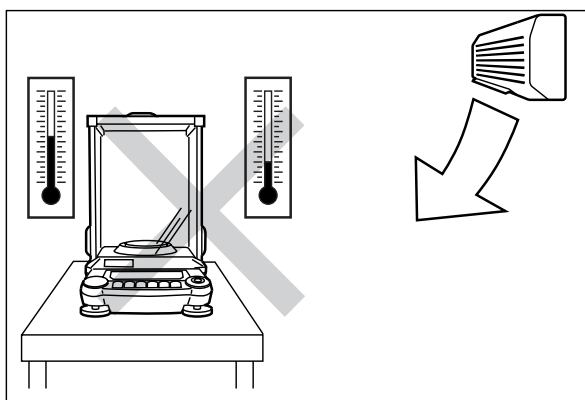

Avoid air current from the air conditioner. When the air conditioner is in operation, the temperature of the air current from it has a large difference from the room temperature. Air current and presence of different temperatures both make the measurement unstable.

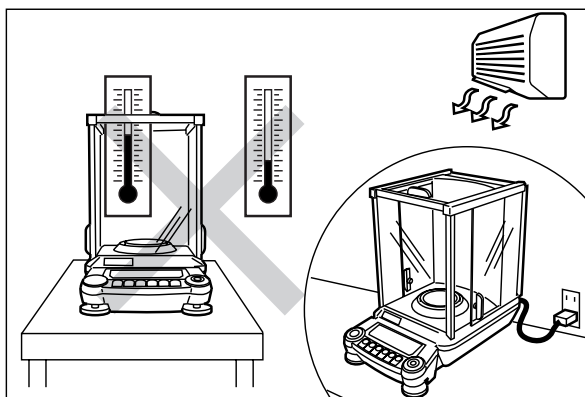

The temperature of the balance does not change as fast as the room temperature. Changing room temperature prior to measurement causes temperature difference remaining for a long period. Even without direct blow of air current, contact of air of different temperatures generate air convection in the weighing chamber and result in unstable display.

- Leave the glass doors open while not in use. This prevents temperature gap between weighing chamber and ambience.

5. Basic Operation (Read Chapters 1 to 5 for basic but proper operation of the balance.)

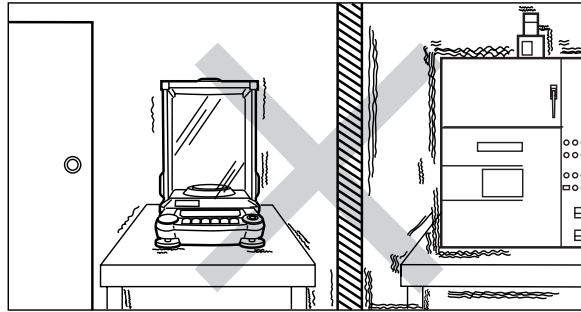

Avoid the location where vibration from any machinery is transmitted.
Corners of a room are less subject to influence of vibration.

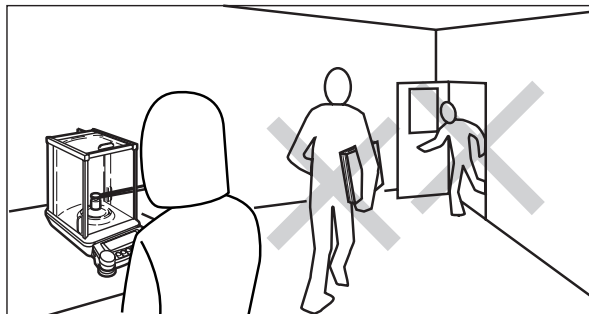

Do not use the door of the room. Do not allow other people enter, exit or move in the room.

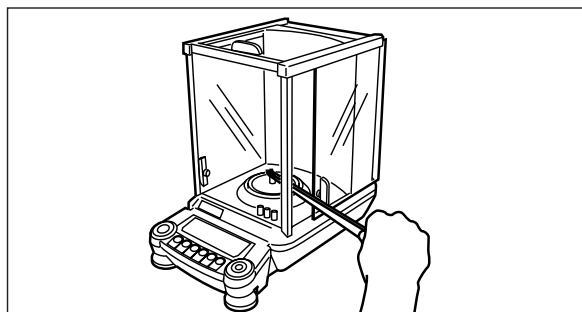

Open glass door minimum. Use long tweezers etc. Equalize the temperature of the samples to the chamber's.

Remove influence of the heat emitted from human body and the heat from the sample to be weighed. Equalize the temperature of the object to be weighed to that of balance weighing chamber (If possible keep the object in the extra space of the chamber prior to measurement). Use a long pair of tweezers, spatula or other instruments to keep hands away from the weighing chamber. Open the glass door as little as possible when loading / unloading.

6. WindowsDirect Function

6.1 What is WindowsDirect?

The AUW-D/AUW/AUX/AUY series can transfer data directly to a computer running MS-Excel, mass input window of analytical instrument software or other applications on Windows® OS, as if the numeric value in the balance display were typed from the keyboard. This function is called WindowsDirect. It uses components that are already part of the Windows OS, and does not need communication software to be installed. Combination with Auto Print function (13.4) is also possible to further enhance productivity. WindowsDirect does not allow the computer to send commands to the balance. In order to control the balances, programming with command codes (14.2.3) is required.

- Only numerical values can be transferred through WindowsDirect.

6.2 WindowsDirect Settings

Simple settings are made for the balance and the computer. Connection is by RS-232C cable specified by Shimadzu.

If bi-directional communication software is used: WindowsDirect function should be turned off. Set up the optimal communication parameters for the software according to “14.3 Communication setting”.

6.2.1 Setting the Balance

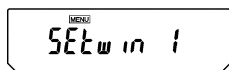
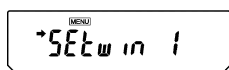
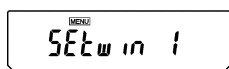

(Example)

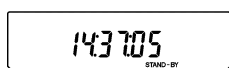

- 1** From the mass display, press the **[MENU]** key twice. “SEtwin |” appears.
- 2** Press the **[O/T]** key. Now all the communication settings for WindowsDirect are made. After setting, the stability mark appears. At this time, pressing the **[O/T]** key again unsets the WindowsDirect and returns the communication settings to the default settings.
- 3** Press the **[POWER]** key to go to STAND-BY, then unplug the AC adapter cable from the balance. This is necessary after the above setting.



Notes

- When data is outputted to the computer by WindowsDirect function, the effect is the same as “typing the numerical value displayed on the balance and pressing Enter key on the computer’s keyboard”. If you wish the effect of “**pressing → key**” instead of “**pressing Enter key**” on the computer’s keyboard”, select “SEtwin -” in the above step 1, instead of “SEtwin |”. The “SEtwin -” setting menu display appears when the **[MENU]** key is pressed one more time from “SEtwin |”.

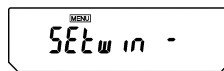

(When not set)

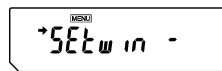

(When set)

- The communication parameters selected by “SEtwin -” or “SEtwin |” settings here are listed in the table in [14.3.2](#).
- After WindowsDirect setting has been made using the “SEtwin -” or “SEtwin |” setting, individual communication parameters can be changed using the Communications Settings menu ([14.3](#)). In this case, the **➔** (stability mark) may still appear if you go to the “SEtwin -” or “SEtwin |” display but WindowsDirect may not operate. To restore WindowsDirect optimal settings then, first remove the stability mark by pressing the **[O/T]** key at the “SEtwin -” or “SEtwin |” display. This restores the default Communications settings. Then, reset “SEtwin -” or “SEtwin |” following the procedure described in [6.2.1](#).

6.2.2 Connecting the RS-232C Cable

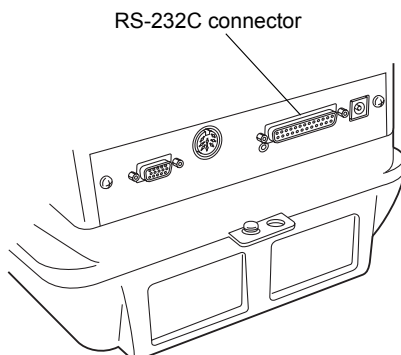

- 1 Check that the balance is in “oFF” or “STANDBY” status.
- 2 Remove power from the balance and turn off the computer.
- 3 Connect the RS-232C cable to the RS-232C connector on the back of the balance.
- 4 Connect the RS-232C cable to the computer.

6. WindowsDirect Function

When using WindowsDirect, use a Null modem cable of one of the below wirings.

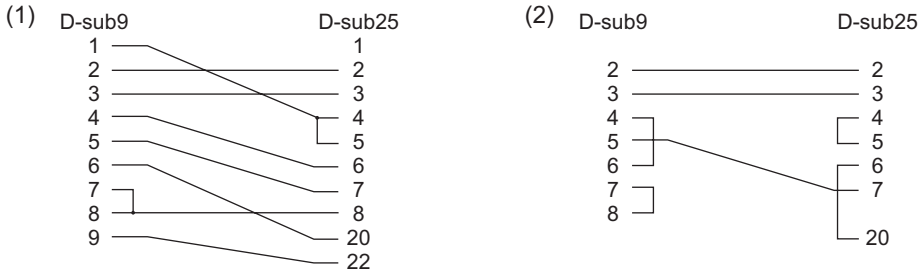

A cable of hte (1) wiring is available as an optional accessory.

RS-232C Cable 25P-9P (1.5m) P/N 321-60754-01

6.2.3 Setting Up the Computer

(leave the balance unplugged)

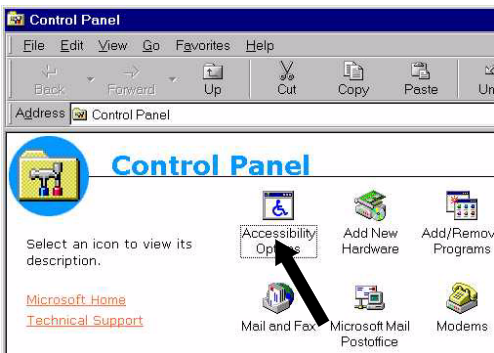

- 1 Turn ON the power to the computer and start Windows®*.
- 2 Click "Start", choose "Settings", and "Control Panel".
- 3 Select "Accessibility Options."
- 4 Verify that there are no check marks for any items on all five tabs including "General."

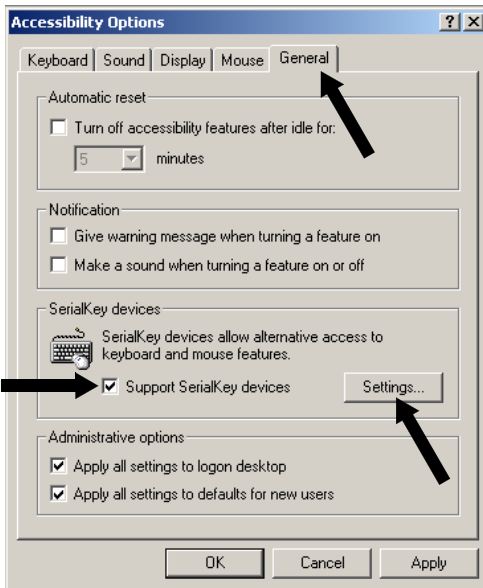

5 Put a check mark at “Support Serialkey device” in the “General” tab. This should be the only check mark on all the tabs of Accessibility Options unless “Administrative options” appears in the “General” tab. Put check marks at both the items of “Administrative options” to maintain the settings even after restarting Windows®.

6 Open “Settings”.

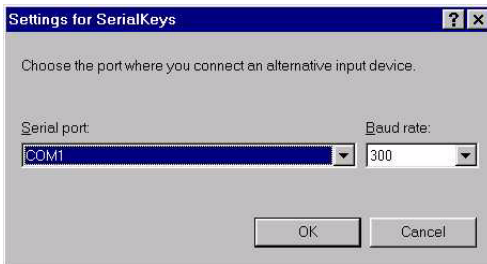

7 Select the serial port corresponding to the RS-232C port of your personal computer. (Serial port: any one of COM1 to 4. Usually, COM1)

8 Select a “Baud rate” of 300.

9 Click “OK”.

10 Click “Apply” and wait.

11 Click “OK”.

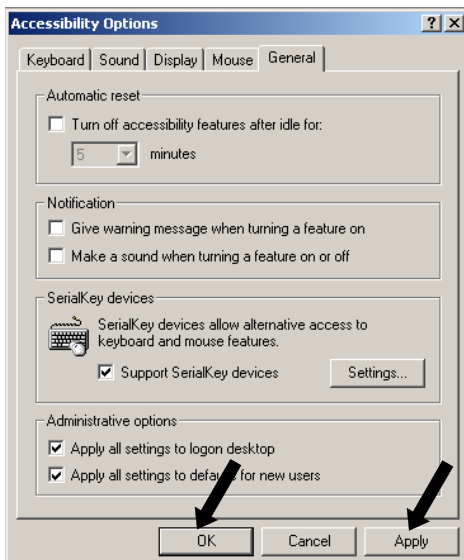

6.2.4 Start and Checking Operation

- 1** Confirm Windows® is free from any application.
- 2** After Windows® has completely started, connect power cable from the AC adapter to the balance, when “oFF” is displayed, press the **[POWER]** key. The mass display appears.



Note

Turning on the balance before Windows®* is completely activated may cause incorrect operation.

- 3** Open the “Note pad” accessory in Windows®* (or start the application you wish to use).
- 4** Press the **[PRINT]** key of the balance. Verify that the numeric value displayed on the balance appears at the cursor position on the screen of computer. The effect is the same as typing the value from the computer keyboard and pressing the ENTER key. Characters indicating the unit of measure are not sent to the computer.
- 5** Test combination with Auto Print function, if you wish to use it.
- 6** End the operation using the standard close or exit procedure.

6.3 Troubleshooting the WindowsDirect Communication Function

If the WindowsDirect communication function doesn't run properly, check the following points.
If this doesn't resolve the problem, contact your Shimadzu representative.

Q1 WindowsDirect communication has been set but it is not operating at all.

A1

- Check the type of communications cable used for the connection (Shimadzu authorized part or another part available on the general market) and the soundness of the connection.
- If a USB serial converter is used, depending on the circumstances at the setup there is a possibility that it has been automatically set to a COM port number higher than 4, and in this case you should reassign it to a COM port number that can be used by serial key devices (COM1 to COM4).
- It is possible that the driver used as an accessory with the USB serial converter has not been set up properly. Try uninstalling the driver and installing it again.
- Some notebook PCs feature a setting for disabling RS-232C ports as a power-saving measure. Before trying to use the WindowsDirect communication function, make the setting that enables the use of RS-232C ports.
- Communications with other applications and PCs via a LAN may interfere with the serial key device settings. Try using WindowsDirect communication without using the LAN.

Q2 The WindowsDirect communication function won't work after I restart the PC.

A2

- Some PCs don't recognize that a serial key device has been set when they start up. For details on how to deal with this, contact your Shimadzu representative.

Q3 I want to use the WindowsDirect communication function with Windows Vista.

A3

- Windows Vista doesn't have the serial device setting screen that is required to set the WindowsDirect communication function. For details on the setting, contact your Shimadzu representative.

Q4 Data is input to the PC as garbled characters.

A4

- Either the balance or the PC is not set for the WindowsDirect connection function. Make the settings again.

Q5 When data is input into Excel, the cursor doesn't move to another cell.

A5

- If a function for conversion to 2-byte characters is available in Windows, turn the setting for this function off.
- Click the [Edit] tab under [Options] in Excel and check [Move selection after Enter] (if cells move in response to keyboard input there is no problem).
- Check the input data in another application (e.g. Notepad).

Q6 The operation is sometimes abnormal.

A6

- Depending on the processing capability of the PC, malfunctions may occur if the communications speed is high. Set 300 bps for the communication speed. Malfunctions may also occur if the interval for data transmission from the balance is too short. Ensure that one batch of data is displayed on the screen before the next batch of data is sent. And if there is limited processing capability, don't use the continuous output function.
- When data is sent from the balance, don't touch the PC's keyboard or mouse.

7. Menu Item Selection

7.1 What is a menu?

The AUW-D/AUW/AUX/AUY series is equipped with many useful functions. The menu is provided to allow the operator to efficiently select the functions that meet the operator's objectives. Understand the menu procedures to gain full command of the functions provided in the AUW-D/AUW/AUX/AUY series. Procedures of each menu item selection are explained with the display examples in chapters 8 to 14. However, when selecting menu items, refer to the menu map for more efficient setting.

7.2 What is a menu map?

The AUW-D/AUW/AUX/AUY series menu consists of four levels. The menu map displays this hierarchy in an easy-to-understand format. The map allows quick access to the menu item desired. Also, it gives the default settings information. The menu map is in Appendices A-1.

7.3 Menu Item Selection Procedures

See the menu map (Appendix A-1).

The AUW-D/AUW/AUX/AUY series menu consists of four levels with the most often used menus in the first level for an easy-to-use structure. The menu can be entered by pressing the **[CAL]** key from the mass display. The menu operation keys for movement in the menu tree are shown in the following table. From any menu level, pressing repeatedly or holding down the **[POWER]** key returns to the mass display.

Operated key	During Menu selection		
	Pressed once and released	Pressed and held for about 3 seconds	Moving direction on Menu Map
[POWER]	Return to the menu above the current menu level.	Returns to mass display.	←
[CAL]	Moves to the next menu item.		↓
[O/T]	Select the displayed menu item, or move to the next menu below the current menu level.		→
[UNIT]	In numerical value input, increases the numeric value of the blinking digit by 1.		
[PRINT]	In numerical value input, moves the blinking digit to the right.		
[1d/10d]	No effect.		

- 1** Press the **[CAL]** key from the mass display. “i-CAL” appears. (The type of regular-use calibration appears. “i-CAL” is default of AUW-D/AUW/AUX series. In the AUY series this is “E-CAL” or “E-tEST”.)
- 2** After that, pressing the **[CAL]** key changes the display in the order shown below.

		Mass display	
(Example)		Execute the preset calibration method (see 10.2, 10.3.1)	
		WindowsDirect setting (down) (see 6.2.1)	
		WindowsDirect setting (right) (see 6.2.1)	
(Example)		Settings check display (see 7.4.1)	
		Standard mode	} Settings for Stability and Response (see 11.2)
		Pouring mode	
		Anti-convection mode	
		High-stability mode	
		Entry to second level (application measurement, individual settings menu group)	
		Entry to second level (system settings menu group)	
		Entry to second level (communication settings menu group)	
		Mass display	

Application measurement, individual settings menu group (Select)

This second level menu group includes settings for selection and execution of alternative calibration method (see 10.2, 10.3.1), zero tracking on/off (see 11.4), stability detection band setting (see 11.3), unit selection/removal (see 12.1), Auto Print on/off, analog display on/off, auto-memory & zeroing mode on/off, and net total measurement mode on/off.

System settings menu group (Select)

This second level menu group includes various settings related to calibration such as settings for the type of regular-use calibration (see 10.3, 10.4), as well as information entries for mediums required for specific gravity measurement (see 13.2, 13.3) and settings related to the clock.

Communication settings menu group (Select)

This second level menu group includes settings for communication formats for connecting the balance to external devices (see 14.3). There are standard formats prepared beforehand and user-defined formats that allow itemized selection.

7.4 Useful Functions Related to Menu

7.4.1 Settings Check Display

From mass display, press the **[CAL]** key four times to display the confirmation of the current settings. Displayed as abbreviations are the three kinds of environmental settings(see 11.), ON/OFF for the fully-automatic span calibration(see 10.3.2,10.3.3), and ON/OFF for the GLP/GMP/ISO compliant calibration report output.(see 10.4.1)

Appears when the fully-automatic span calibration PSC or Clock-CAL is on.

Appears when the calibration report output is on

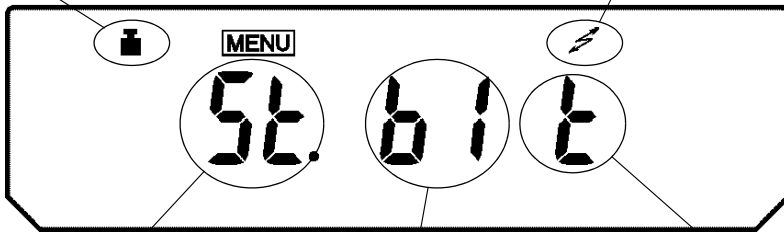

Stability and response setting

St : Standard mode
Co : Anti-convection mode
Hi : High-stability mode
Po.n : Pouring mode (normal environment)
Po.S : Pouring mode (very stable environment)
Po.U : Pouring mode (unstable environment)

Stability detection band setting

b1 : 1 count
b5 : 5 count
b10 : 10 count

Appears when zero tracking is on

The weight symbol appears when either or both of the fully-automatic span calibration PSC or Clock-CAL are on.

7.4.2 Returning to Default Settings (Menu reset)

This will return all the settings to default. The reference value stored in previous use of piece counting or percentage conversion and the set time of Interval Timer function will also be cleared. The default settings are indicated with “#” on the Menu Map.



- 1** Press the **[CAL]** key repeatedly until “SEtting” appears. Press the **[O/T]** key. The display shows “CAL dEF”.
- 2** Press the **[CAL]** key repeatedly until the display shows “rESEt”. Press the **[O/T]** key. The display shows “rESEt?” for confirmation.
- 3** Press the **[O/T]** key one more time.

7.4.3 Menu Lock

The menu setting operations can be locked so that the settings cannot be inadvertently changed. This is called Menu Lock. WindowsDirect settings also lock. The menu lock is set with the following procedure.

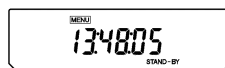
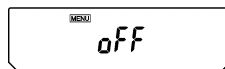
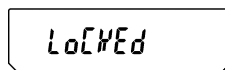

(Time is not displayed with AUY.)

If a menu item selection is attempted in locked status, the message "LoCKEd" appears and the menu selection is not allowed. To allow menu selections again, follow this procedure.

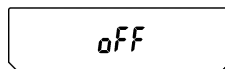
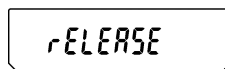
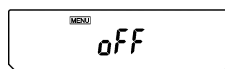

How to lock the menu

- 1** Connect the balance to the power and wait.
- 2** When "oFF" appears, press and hold the [CAL] key for about three seconds. "LoCKEd" appears and the menu lock function is activated, returning to the "oFF" display. When the lock function is activated, the MENU mark appears.

When menu is locked, MENU symbol is illuminated at STAND-BY display, too.

How to remove menu lock

- 1** Disconnect the balance from power. Wait, then connect power again.
- 2** When "oFF" appears, press and hold the [CAL] key for about three seconds.
- 3** "rELEASE" appears and the menu lock is released.

8. Setting the Built-in Clock

(AUW-D/AUW/AUX series only)

AUW-D/AUW/AUX series are installed with a built-in clock. Set the clock before use of Clock-CAL (10.3.3) or Calibration report (10.4.1) functions. Note that the current time is displayed during STAND-BY mode (4.4).

8.1 Date

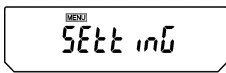

(Example)

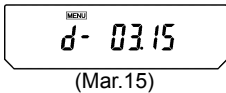

(Example)

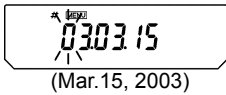

(Example)



1 From the mass display, press the **[CAL]** key repeatedly until “SEtting” appears, press the **[O/T]** key. “CAL dEF” will appear.

2 Press the **[CAL]** key repeatedly until “d-MM.DD” appears (MM and DD are each two digits representing month and date, respectively), and press the **[O/T]** key. In the upper part of the display, the **[MENU]** mark and the # symbol appear indicating number entry mode. Also, the current date setting appears as [YY.MM.DD] (YY is the year) with the leftmost digit blinking.

3 Pressing the **[UNIT]** key increases the blinking digit by one. Pressing the **[PRINT]** key moves the blinking digit one place to the right.

4 Press the **[O/T]** key when the desired date is shown in the display. The built-in clock will be set.

5 Press the **[POWER]** key repeatedly to return to the mass display.



Note

The actually outputted date format is not the same as the display during this setting. Select your desirable style of expressing year, month and date in 8.2.

8.2 Date Output Style

The order of the year, the month and the date in the external output can be selected from three styles.

MENU
SEtting

MENU
CAL dEF

MENU
StYLdAtE

MENU
→ y-m-d

(When YYYY-MM-DD is selected)

MENU
m-d-y

MENU
d-m-y

MENU
→ d-m-y

(When DD-MM-YYYY is selected)

MENU
StYLdAtE

- 1** From the mass display, press the **[CAL]** key repeatedly until “SEtting” appears, press the **[O/T]** key. “CAL dEF” will appear.
- 2** Press the **[CAL]** key repeatedly until “StYLdAtE” appears.
- 3** Press the **[O/T]** key.
The display shows “y-m-d”.
After this, pressing the **[CAL]** key cycles the displays in the order of “y-m-d” → “m-d-y” → “d-m-y” → “y-m-d”.
“y-m-d” is for setting YYYY-MM-DD, “m-d-y” is for MM-DD-YYYY and “d-m-y” is for DD-MM-YYYY.
When the current setting is displayed, the stability mark (→) appears. To change the setting, press the **[O/T]** key when the desired setting is on the display, or
- 4** Press the **[POWER]** key to return to “StYLdAtE” without changing the setting.
- 5** Pressing the **[POWER]** key again returns to the mass display.

8.3 Time

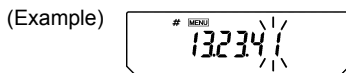
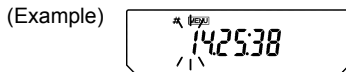
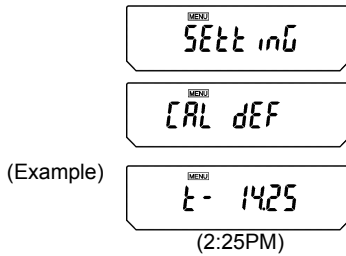

1 From the mass display, press the **[CAL]** key repeatedly until “SEttinG” appears. Press the **[O/T]** key. “CAL dEF” will appear.

2 Press the **[CAL]** key repeatedly until “t-HH.MM” appears (HH and MM are each two digits representing hour and minute, respectively), and press the **[O/T]** key.

3 In the upper part of the display, the **[MENU]** symbol and the # symbol appear indicating number entry status. Also, the current time setting appears as [HH.MM.SS] (HH is hours, MM is minutes, and SS is seconds) with the leftmost digit blinking.

4 Pressing the **[UNIT]** key increases the blinking digit by one. Pressing the **[PRINT]** key moves the blinking digit one place to the right.

5 Press the **[O/T]** key when the desired time is shown in the display. The built-in clock will be set.

6 Press the **[POWER]** key repeatedly to return to the mass display.

9. Display Settings

9.1 Bar Graph Display

This function displays a bar graph representation of the load on the pan. This may be used to prevent sudden appearance of “oL” (overload) during measurement. This bar graph display can be turned on or off.

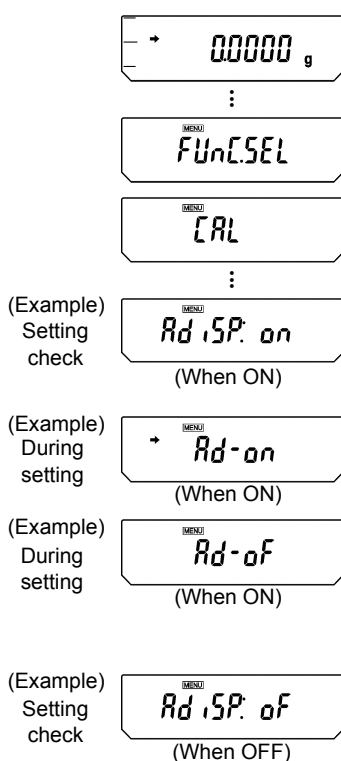

Bar graph in weighing

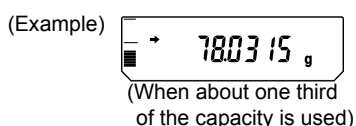

Setting ON/OFF

- 1** Press the **[CAL]** key repeatedly from the mass display and when “Func.SEL” appears, press the **[O/T]** key. “CAL” is displayed.
- 2** Press the **[CAL]** key repeatedly until “AdiSP:**” appears. The ** position displays the current setting “on” or “oF”.
- 3** Press the **[O/T]** key. “Ad-on” is displayed. At this point, pressing the **[CAL]** key switches the display between “Ad-on” and “Ad-oF”. When the current setting is displayed, the stability mark (➔) appears. To change the setting, press the **[O/T]** key when the desired setting appears, and the display will return to “AdiSP:**”, indicating the new setting.
- 4** If no change is required, press the **[POWER]** key. The display returns to “AdiSP:**”.
- 5** Press the **[POWER]** key repeatedly to return to the mass display.

9.2 Changing the Minimum Display (AUW/AUX/AUY series only)

Not applicable to a verified balance as a legal measuring instrument in the EU

The AUW/AUX/AUY series allow the minimum display to be changed by one digit if desired. The last decimal place will be rounded and removed from the display.



1 (To change the minimum display by one digit)

Press the **[1d/10d]** key from the mass display. The minimum display digit will be displayed with only three decimal places.

2 (To return the minimum display to the standard setting)

Press the **[1d/10d]** key from the mass display. The minimum display digit will return to the previous setting.



Note

The decimal point does not move. When the minimum display is changed by one decimal place, the final decimal place remains empty.

9.3 Turning the Backlight On and Off

(AUW series only) (Not for AUW-D)

The AUW series is equipped with a backlight for the display to allow easy viewing regardless of the surrounding lighting conditions. The backlight can be switched on and off.

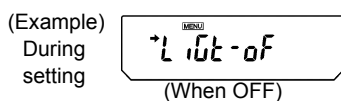
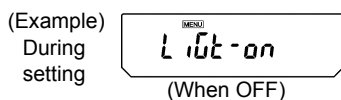
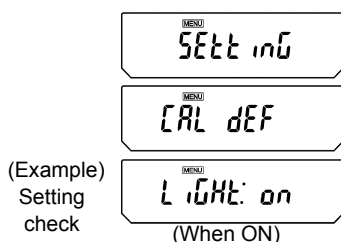

- 1** Press the **[CAL]** key repeatedly from the mass display until “SEtting” appears. Press the **[O/T]** key. “CAL DEF” appears.
- 2** Press the **[CAL]** key and the display shows “LiGht:***”. The ** position shows “on” for on, and “oF” for off.
- 3** To change the settings, press the **[O/T]** key when the “LiGht:***” appears. The display shows “LiGt-on”.
- 4** From that point, every time the **[CAL]** key is pressed, the display switches between “LiGt-on” (on), and “LiGt-oF” (off). Here, when the current setting is displayed, the stability mark (→) appears.
- 5** Press the **[O/T]** key when the desired setting appears, and the display will return to “LiGht:***”, indicating the new setting.
- 6** If no change is required, press the **[POWER]** key to return to “LiGht:***”.
- 7** Press the **[POWER]** key repeatedly to return to the mass display.



Note

When backlight is used for normal operations, any required “warm-up” should also be performed with backlight on. Leave the balance in mass display, rather than “STAND-BY” for the required warm-up period. (See 4.4)

10. Calibration

10.1 What is calibration?

10.1.1 The Necessity of Calibration

Calibration is required to accurately weigh items with an electric balance. Calibration must be performed in these conditions:

- When the location of the installation site is changed (even when moved within the same room).
- When the room temperature changes.
- Also, daily calibration before use is recommended.

The AUW-D/AUW/AUX series are set to operate fully-automatic span calibration PSC by default. The AUJ series requires span calibration using external weights.

The Essential Role of Span Calibration for the Use of Electronic Balances

The measurement desired when using an electronic balance is the measurement of mass. However, an electronic balance cannot detect mass directly. Instead, it detects the weight (the weight is the Earth's attraction on the item, gravity) and displays the mass as computed from the weight. The proportion of mass to weight depends on the gravitational acceleration at the location. By placing calibration weights of accurately known mass on the electronic balance, the corresponding weight for that mass can be recorded. This allows the mass of any item that is subsequently weighed to be computed from its weight and accurately displayed. The recording and setting of weight-mass relation is known as span calibration.

The necessity can be recognized this way for example, the gravitational acceleration in the Japanese cities of Kyoto and Tokyo are 979.70775 cm/s^2 and 979.76319 cm/s^2 respectively, with a difference of about 0.0057%. This means that if a balance is calibrated in Kyoto and the balance is moved to Tokyo, an object of 100.0000g mass will exhibit 100.0057g on the balance, generating an error of two digits.

Always perform span calibration at the installation site before using the balance to correct for this effect.

In addition, electronic balances use a permanent magnet and a coil in their weight detecting system. Even with compensation, a permanent magnet generates a sensitivity difference of up to $\pm 2 \text{ ppm}$ (two millionths) with every 1°C fluctuation in temperature. When measuring for example, a 100g object, this difference amounts to $\pm 2 \text{ mg}$, which means a possible error on the final two digits displayed on the electronic balance. If the temperature changes by 5°C after calibration, an object of 100.0000g may appear to increase to a maximum of 100.0010g. When there is a change in temperature, always calibrate again for accurate measurement.



Note

Using a verified balance as a legal measuring instrument in the EU:

The balance must be used within the temperature range indicated on the verification label.

When PSC (refer to [10.3.2](#)), fully-automatic span calibration, is not activated, operator must carry out span calibration (refer to [10.2](#)) upon blinking of the Weight Symbol.

10.1.2 Types of Calibration

Terms used in this manual:

Span calibration	Adjustment of the balance sensitivity using two weight values, zero and near-capacity
Calibration test	Comparing the current calibration mass reading to the calibration mass reading after the last span calibration.
Calibration	Specifies both span calibration and calibration test.

The AUW-D/AUW/AUX series have a built-in, motor-driven calibration weight. This weight allows easy key calibration operations (i-CAL, i-tEst) without having to maintain external weights and manually load and unload weights. These models are also equipped with functions for performing fully-automatic span calibration whenever necessary. The two functions are PSC, for executing automatic span calibration made necessary by temperature changes, and Clock-CAL, for performing automatic span calibration at set times. Calibration can also be done with external calibration weights (E-CAL, E-tEst). Calibration of the built-in calibration weight with external calibration weights (PCAL) is also possible. Calibration of the AUW series must be done with external calibration weights as this series does not have a built-in calibration weight.

Calibration					
Span calibration (Balance is adjusted)				Calibration test (Check only)	
Fully-automatic		Built-in	External	Built-in	External
PSC*1 (→10.3.2)	Clock-CAL (→10.3.3)	i-CAL*2 (→10.2.1)	E-CAL*3 (→10.2.2)	i-tEst (→10.2.3)	E-tEst (→10.2.4)
AUW-D AUW AUX	AUW-D AUW	AUW-D AUW AUX	AUW-D AUW AUX AUW	AUW-D AUW AUX	AUW-D AUW AUX AUW

Each calibration type is available for the listed series only.

*1 Default setting is ON for AUW-D / AUW / AUX

*2 Default preset calibration method for AUW-D/AUW/AUX

*3 Default preset calibration method for AUW

10.2 Executing Calibration

Perform calibration only after correct installation and thorough warm up. Also, make sure that nothing is on the pan and ensure conditions free from the influence of vibrations or wind.

10.2.1 Span Calibration With Built-in Weight (AUW-D/AUW/AUX series only)

“i-CAL” (The balance will be adjusted with the built-in calibration weight.)

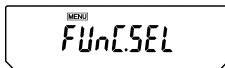

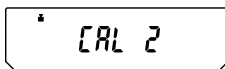

⋮

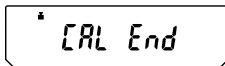

1 From the mass display, press the **[CAL]** key once. If the display shows “i-CAL” (Preset calibration method is “i-CAL”), jump to Step 5.

If the display shows another item (Preset calibration method is not “i-CAL”), go on to Step 2.

(Refer to [10.3.1](#) for preset calibration method)

2 Press the **[CAL]** key repeatedly until “FUnC.SEL” appears, then, press the **[O/T]** key to display “CAL”.

3 Press the **[O/T]** key again. The display shows “E CAL”.

4 Press the **[CAL]** key twice. The display shows “i-CAL”.

5 Press the **[O/T]** key. The motor sound of weight loading system is heard and the display changes automatically in this order: “CAL 2”, “CAL 1”, “CAL 0”, and “CAL End”.

When the display returns to the mass display, span calibration is complete.

10.2.2 Span Calibration With External Weights

“E-CAL” (The balance will be adjusted with external calibration weights)

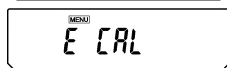
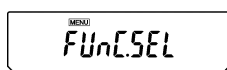

(Example)

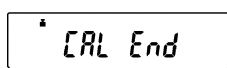
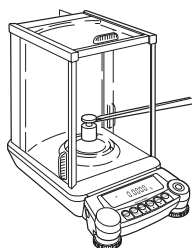

- 1** From the mass display, press the **[CAL]** key once. If the display shows “E CAL” (Preset calibration method is “E-CAL”), jump to Step 4. If the display shows another item (Preset calibration method is not “E-CAL”), go on to Step 2. (Refer to [10.3.1](#) for preset calibration method)
- 2** Press the **[CAL]** key repeatedly until “FUnC.SEL” appears, then press the **[O/T]** key to display “CAL”.
- 3** Press the **[O/T]** key. The display shows “E CAL”.
- 4** While “E-CAL” is shown, press the **[O/T]** key. Span calibration begins and the zero display blinks.
- 5** Recheck that there is nothing on the pan and wait.
- 6** The set weight value (Refer to [10.3.5](#)) appears, blinking.
- 7** Place the weight indicated on the pan. Wait until the blinking zero display reappears. (It may take about 30 seconds.)
- 8** Remove the calibration weight. After “CAL End” appears for several seconds, the display returns to the mass display and the span calibration is complete.

10.2.3 Calibration Check With Built-in Weight (AUW-D/AUW/AUX series only)

“i-tEst” (The balance is checked with the built-in weight but not adjusted.)

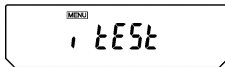
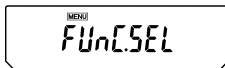
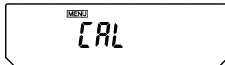
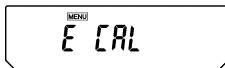
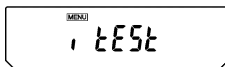
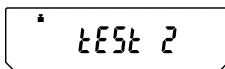
(Example)

1 From the mass display, press the **[CAL]** key once. If the display shows “i tEst” (Preset calibration method is “i-tEst”), jump to Step 5.

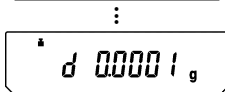
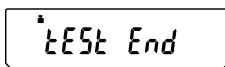
If the display shows another item (Preset calibration method is not “i-tEst”), go on to Step 2.

(Refer to [10.3.1](#) for preset calibration method)

2 Press the **[CAL]** key repeatedly until “FuNC.SEL” appears, then, press the **[O/T]** key to display “CAL”.

3 Press the **[O/T]** key again. The display shows “E CAL”.

4 Press the **[CAL]** key repeatedly until the display shows “i tEst”.

5 Press the **[O/T]** key. The display changes automatically in this order: “tEst 2”, “tEst 1”, and “tEst 0”. After that, the display shows the drift from the previous span calibration for several seconds.

6 After “tEstEnd” appears for several seconds, the display returns to the mass display, and the calibration test is complete.

Note that the Calibration Test procedure DOES NOT adjust the balance, it only reports the drift from the previous span calibration.

10.2.4 Calibration Check With External Weights

“E-tEst” (The balance is checked with external calibration weights but not adjusted.)

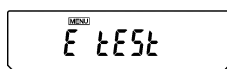
 E tEst

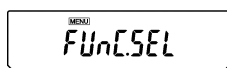
 FUnC.SEL

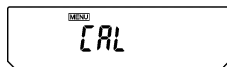
 CAL

 E CAL

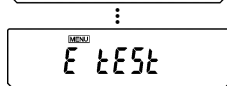
 E tEst

 000000

(Example)

 2000000

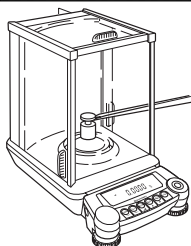

 000000

(Example)

 0.00001 g

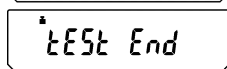
 tEst End

 000000 g

- 1** From the mass display, press the **[CAL]** key once. If the display shows “E tEst” (Preset calibration method is “E-tEst”), jump to Step 5. If the display shows another item (Preset calibration method is not “E-tEst”), go on to Step 2. (Refer to [10.3.1](#) for preset calibration method)
- 2** Press the **[CAL]** key repeatedly until “FUnC.SEL” appears, then, press the **[O/T]** key to display “CAL”.
- 3** Press the **[O/T]** key. The display shows “E CAL”.
- 4** Press the **[CAL]** key repeatedly until the display shows “E tEst”.
- 5** Press the **[O/T]** key. The calibration test begins and the zero display blinks.
- 6** Recheck that there is nothing on the pan and wait.
- 7** The set weight value (Refer to [10.3.5](#)) appears, blinking.
- 8** Place the weight indicated on the pan. Wait until the blinking zero display reappears. (It may take about 30 seconds.)
- 9** Remove the weight. The display shows the drift from the previous span calibration for several seconds. Then, after “tEst End” appears for several seconds, the display returns to the mass display, and the calibration test is complete. Note that the Calibration Test procedure DOES NOT adjust the balance, it only reports the drift from the previous span calibration.

10.3 Calibration Settings

One of the following four calibration methods listed in the below step 3 is selected as “preset calibration method”. Preset calibration method will be called with only one key touch from the mass display for convenience of frequent use. Select your most frequently used method here. The default setting is “i-CAL” (“E-CAL” for AUJ). The rest of the methods are alternative calibration methods, which can also be performed at any time by entering the function selection menu. Procedures for performing each calibration method as the preset or as an alternative calibration method are described in 10.2.

10.3.1 Selecting Preset Calibration Method



(Displays of four menu items)

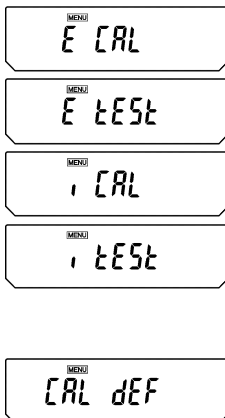

1 From the mass display, press the **[CAL]** key repeatedly until the “SEtting” menu appears. Press the **[O/T]** key. “CAL dEF” appears.

2 When “CAL dEF” appears, press the **[O/T]** key. The “E CAL” display appear.

3 Press the **[CAL]** key repeatedly until the desired setting appears. Select from the following four types (or two types for AUJ series). The stability mark appears when the currently preset method is shown.

“E CAL”: Span Calibration with external weights (E-CAL)

“E tEst”: Calibration test with external weights (E-tEst)

“i CAL”: Span Calibration with built-in calibration weight (i-CAL)
(AUW-D/AUW/AUX series only)

“i tEst”: Calibration test with built-in calibration weight (i-tEst)
(AUW-D/AUW/AUX series only)

4 Press the **[O/T]** key when the desired calibration setting appears. “CAL dEF” appears when the setting is made.

5 Press the **[POWER]** key to return. The calibration type set here can be executed by simply pressing the **[CAL]** key followed by the **[O/T]** key from mass display.

10.3.2 PSC Fully-automatic span calibration (AUW-D/AUW/AUX series only)

Using a temperature sensor, this function performs fully-automatic span calibration with the built-in weight when a significant temperature change is detected.

If PSC turned ON, when there is a temperature change that would influence sensitivity, span calibration executes automatically to maintain the sensitivity of the balance. Span Calibration executes automatically in mass display mode under any of the following circumstances.

- (1) When there is a change in the surrounding temperature
- (2) When about four hours has passed since the previous calibration.
- (3) After either condition (1) or (2) above has been met during warm up at stand-by status, when the balance is switched to mass display mode.

In mass display mode, when any of the conditions above has been met, the weight symbol will blink for about two minutes as notification of span calibration before calibration begins.

The sensitivity before and after span calibration is slightly different. Also, no measurements can be made during span calibration. When you wish to avoid entering span calibration in the middle of one round of measurements, pressing the **[POWER]** key when the weight symbol is blinking will abort the automatic span calibration.



Note

Using a verified balance as a legal measuring instrument in the EU:

The balance must be used within the temperature range indicated on the verification label.

When PSC is not activated, operator must carry out span calibration (refer to [10.2](#)) upon blinking of the Weight Symbol.



Caution

Make certain that no object is on the pan and all the doors are closed during span calibration. Never cause vibration of the balance during calibration.

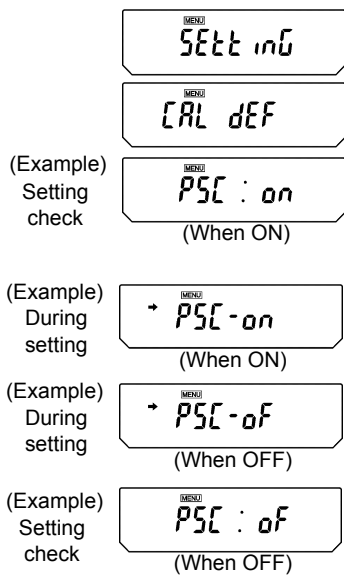

Display at PSC operation

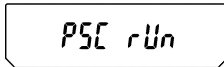

PSC and Clock-CAL can each be turned on and off independently. Weight symbol appears in the Settings Check Display (see 7.4.1) when either or both of PSC and Clock-CAL are on.

Setting PSC ON/OFF

- 1** From mass display, press the **[CAL]** key repeatedly until “SEtting” appears. Press the **[O/T]** key to display “CAL dEF”.
- 2** Press the **[CAL]** key repeatedly until “PSC:**” appears. The ** positions show the current setting, either “on” when on or “oF” when off.
- 3** To change the setting, press the **[O/T]** key when “PSC:**” appears.
- 4** “PSC-on” appears and from this point, every time the **[CAL]** key is pressed, the display switches between “PSC-oF” and “PSC-on”. Here, when the current setting is displayed, the stability mark (→) appears. When the desired setting appears, pressing the **[O/T]** key changes the current setting. Pressing the **[POWER]** key returns the setting to “PSC:**” without changing the setting.
- 5** Press the **[POWER]** key repeatedly to return to the mass display.

10.3.3 Clock-CAL Fully-automatic span calibration (AUW-D/AUW series only)

The balance can be set to execute fully-automatic span calibration at set times (up to three times a day) with the built-in weight and the built-in clock. Clock-CAL is a very convenient function, when calibration reports are desired for regular calibrations, or to schedule span calibrations during break times to avoid interruption of measurement work.

The weight symbol blinks for about two minutes as notification of span calibration before it begins. Pressing the **[POWER]** key during the notification blinking halts the automatic span calibration.



Caution

Make certain that no object is on the pan and all the doors are closed during span calibration. Never cause vibration of the balance during calibration.

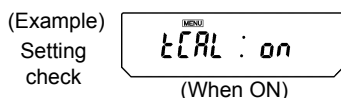
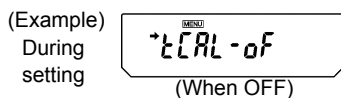
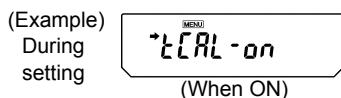
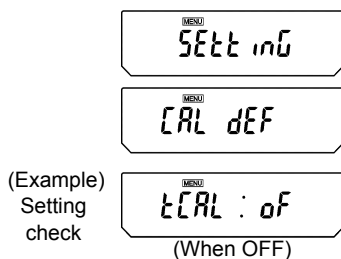

Setting Clock-CAL ON/OFF

- 1** From mass display, press the **[CAL]** key repeatedly until “SEtting” appears. Press the **[O/T]** key to display “CAL DEF”.
- 2** Press the **[CAL]** key repeatedly until “tCAL:**” appears. The ** positions show the current setting, either “on” when on or “oF” when off.
- 3** To change the setting, press the **[O/T]** key when “tCAL:**” appears.
- 4** “tCAL-on” appears and from this point, every time the **[CAL]** key is pressed, the display switches between “tCAL-oF” and “tCAL-on”. Here, when the current setting is displayed, the stability mark (→) appears. When the desired setting appears, pressing the **[O/T]** key changes the current setting. Pressing the **[POWER]** key returns the setting to “tCAL:**” without changing the setting.
- 5** Press the **[POWER]** key repeatedly to return to the mass display.

(Example)

(For the t1 setting)

(Example)

(When setting for the first time)

(Example)

(Showing 12:30)

(Example)

(When set for 3:15 PM.)

Setting the time for Clock-CAL

- 1 From mass display, press the **[CAL]** key repeatedly until “SEtting” appears. Press the **[O/T]** key to display “CAL DEF”
- 2 Press the **[CAL]** key repeatedly until “tCAL t*” appears. Press the **[O/T]** key to display “t* HH:MM”. The * position shows the reference number of the time setting, a numeral from 1 to 3. The currently set time is displayed as “HH:MM” (HH is the hours and MM is the minutes), with the leftmost digit blinking. The time appears as _ _ : _ _ when no time is set. The **[MENU]** symbol, and the # symbol appear to indicate the display is in the numerical input mode.
- 3 The numeral of the blinking digit may be changed. Pressing the **[PRINT]** key moves the blinking digit one place to the right. Press the **[UNIT]** key to change the value of the blinking digit. When the **[UNIT]** key is pressed, the value of the blinking digit increases by 1 at a time. The numerals progress in this order: 0→1→2→...→9→_→0... Set the hours in the range from 00 to 23 and the minutes from 00 to 59. Press the **[O/T]** key to complete the setting. The display returns to “t CAL t *”.
- 4 To set another time, press the **[CAL]** key to move to the next “t CAL t*” setting and set the time in the same way.
- 5 After completing the setting, press the **[POWER]** key to return to the mass display.

Clearing the Settings

The Clock-CAL settings “tCAL t1” to “tCAL t3” may each be reset by using procedure 3 to set the time to _ _ : _ _.

PSC and Clock-CAL can each be set on and off independently. Weight mark appears in the settings Check Display (see 7.4.1) when either or both of PSC and Clock-CAL are on.

10.3.4 PCAL: Calibration of the Built-in Weight (AUW-D/AUW/AUX series only)



Note

Not applicable to a verified balance as a legal measuring instrument in the EU.

The built-in calibration weight is already calibrated before shipping but the operator can also calibrate the built-in calibration weight using their own external calibration weights. The calibration of the built-in calibration weight is called PCAL. Inputting the conventional mass value (s) of the operator's calibration weight (s) can provide the most accurate span calibration (refer to 10.3.6). Perform span calibration only after correct installation and thorough warm up. Also, make sure that nothing is on the pan and ensure conditions free from the influence of vibration or air flow.

SEtting

CAL DEF

PcAL

* PCAL

(Example)

2000000 g

00000 g

* PCAL 1

* PCAL 0

:

00000 g

- 1** From mass display, press the [CAL] key repeatedly until "SEtting" appears. Press the [O/T] key. "CAL DEF" appears.
- 2** Press the [CAL] key repeatedly until "PcAL" appears and press the [O/T] key. Calibration of the built-in calibration weight begins and the display shows "PCAL" (the C becomes capital).
- 3** When the display shows a value, "XXX.XXXX", place the weight of the value displayed on the pan. (Refer to 10.3.6)
- 4** After that, "0.0000" is displayed. Remove the calibration weights from the pan.
- 5** The display changes automatically from "PCAL 1" to "PCAL 0". (The built-in weight is being loaded and unloaded.)
- 6** When the display returns automatically to the mass display, the calibration is complete.

10.3.5 Inputting External Calibration Weight Value for E-CAL

The exact value (conventional mass value) of the operator's calibration weight to be used for E-CAL and E-tEst procedures can be entered.

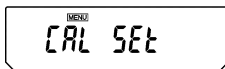
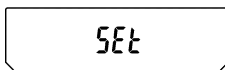
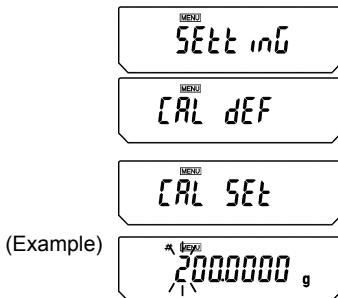

1 From mass display, press the **[CAL]** key repeatedly until “SETtinG” appears. Press the **[O/T]** key. “CAL dEF” appears.

2 Press the **[CAL]** key repeatedly until “CAL SET” appears and press the **[O/T]** key. One of these numbers will appear, depending on the model: 50.0000g, 100.0000g, 200.0000g, or 300.0000g. In the upper part of the display panel, the **[MENU]** symbol and the **#** symbol appear in order to indicate numerical input mode. The leftmost numeral blinks. The blinking digit may be changed.

3 When the **[UNIT]** key is pressed, the value of the blinking digit increases by 1 at a time. Press the **[PRINT]** key to move the blinking digit one place to the right. Enter the desired value.

4 Press the **[O/T]** key to set the external calibration weight value. The display proceeds to “SET” and then to “CAL SET”.

5 Press the **[POWER]** key again to return to the mass display.

Calibration Weight Value Range

AUW-D series	220D	75g to capacity
	120D	35g to capacity
Other series	320	145g to capacity
	220	95g to capacity
	120	45g to capacity



Note

In the AUW-D series the conventional mass value may be input for up to five decimal places.

10.3.6 Inputting External Calibration Weight Value for PCAL



Note

Not applicable to a verified balance as a legal measuring instrument in the EU.

The exact value (conventional mass value) of the operator's calibration weight to be used for PCAL procedure can be entered.

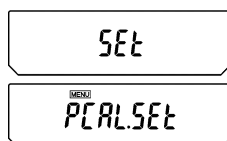
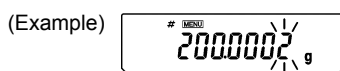
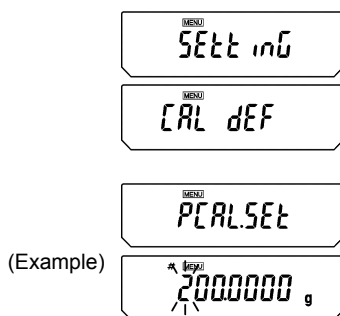

- 1** From mass display, press the **[CAL]** key repeatedly until "SETtinG" appears. Press the **[O/T]** key. "CAL dEF" appears.
- 2** Press the **[CAL]** key repeatedly until "PCAL Set" appears and press the **[O/T]** key. One of these numbers will appear, depending on the machine model: 50.0000g, 100.0000g, 200.0000g, or 300.0000g. In the upper part of the display panel, the **[MENU]** symbol and the # symbol appear in order to show number entry mode. The leftmost numeral blinks. The blinking digit may be changed.
- 3** When the **[UNIT]** key is pressed, the value of the blinking digit increases by 1 at a time. Press the **[PRINT]** key to move the blinking digit one place to the right. Enter the desired value.
- 4** Press the **[O/T]** key to set the external calibration weight value for built-in weight calibration. The display proceeds to "Set", then to "PCAL SET".
- 5** Press the **[POWER]** key again to return to the mass display.

Calibration Weight Value Range

AUW-D series	220D	75g to capacity
	120D	35g to capacity
Others series	320	145g to capacity
	220	95g to capacity
	120	45g to capacity



Note

In the AUW-D series the conventional mass value may be input for up to five decimal places.

10.4 For GLP/GMP/ISO Compliance

10.4.1 Calibration Report Setting

Setting the calibration report provides an automatic calibration record output every time span calibration or calibration test is performed. An optional electronic printer (see 14.1) can save reports by printing them. Combination with Clock-CAL function (see 10.3.3) provides fully-automatic and periodical calibration and reports.

(Example) Setting check

MENU
SEtting

MENU
CAL dEF

(Example) Setting check

MENU
GLP : oF

(When OFF)

(Example) During setting

MENU
GLP-on

(When OFF)

(Example) During setting

MENU
→ GLP-on

(When ON)

(Example) Setting check

MENU
GLP : on

(When set to ON)

1 From mass display, press the **[CAL]** key repeatedly until “SEtting” appears. Press the **[O/T]** key. “CAL dEF” appears.

2 Press the **[CAL]** key repeatedly until “GLP: **” appears. The ** positions show the current setting, “on” when set and “oF” when unset.

3 To change the setting press the **[O/T]** key when “GLP: **” is showing. The display will show “GLP-on”. (The “:” becomes “-”)

4 From this point, every time the **[CAL]** key is pressed, the display will switch between “GLP-oF” and “GLP-on”. Here, when the current setting is displayed, the stability mark (→) appears.

5 To change the setting, press the **[O/T]** key when the desired setting appears, or

6 Press the **[POWER]** key to return to “GLP: **” without changing the setting.

7 Press the **[POWER]** key again to return to the mass display.



Note

Date output, ID number etc. of electronic printer EP-50 or EP-90 should be turned off when calibration report is produced.

10.4.2 Balance ID Setting

This setting is for the balance ID number that is output along with the calibration report.

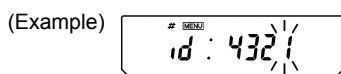
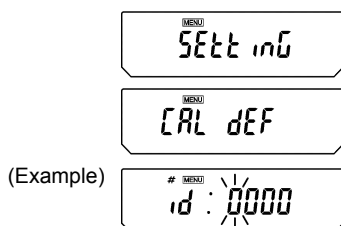

- 1** From mass display, press the **[CAL]** key repeatedly until “SEtting” appears. Press the **[O/T]** key. “CAL DEF” appears.
- 2** Press the **[CAL]** key repeatedly until “id: ****” appears. (The **** is a number.) Press the **[O/T]** key. In the upper part of the display panel, the **[MENU]** symbol and the # symbol appear in order to indicate numerical input mode. The left-most digit of **** blinks. The numeral of the blinking digit can be changed.
- 3** Press the **[UNIT]** key to increase the value of the blinking digit by 1. Press the **[PRINT]** key to set that digit and move the blinking digit one place to the right. When the desired setting is entered, press the **[O/T]** key to confirm the balance ID number.
- 4** Press the **[POWER]** key to return to “id: ****”. (No blinking)
- 5** Press the **[POWER]** key again to return to the mass display.

10.4.3 Date Printout Setting

This setting determines whether or not the date and time on the balance's built-in clock is printed out along with the calibration report.

MENU
SEtting

MENU
CAL dEF

(Example)
Setting
check

MENU
Prtdt: on

(When ON)

(Example)
During
setting

MENU
*Prdt-on

(When ON)

(Example)
During
setting

MENU
*Prdt-of

(When OFF)

(Example)
Setting
check

MENU
Prtdt: of

(When OFF)

- 1** From mass display, press the **[CAL]** key repeatedly until "SEtting" appears. Press the **[O/T]** key. "CAL dEF" appears.
- 2** Press the **[CAL]** key repeatedly until "Prtdt:**" appears. The ** positions show the current setting, "on" when set (print) and "oF" when unset (do not print).
- 3** To change the setting, press the **[O/T]** key when "Prtdt:**" is showing. The display will show "Prdt-on". (The "." becomes "-")
- 4** From this point, every time the **[CAL]** key is pressed, the display will switch between "Prdt-oF" and "Prdt-on". Here, when the current setting is displayed, the stability mark (➔) appears.
- 5** To change the setting, press the **[O/T]** key when the desired setting appears, or
- 6** Press the **[POWER]** key to return to "Prtdt: **" without changing the setting.
- 7** Press the **[POWER]** key again to return to the mass display.

11. Environment Settings

11.1 What are environmental settings?

The response and other settings can be changed to adapt to the installation environment (for example, unavoidable vibrations or air currents) or measurement uses (for example, depending on whether solid objects, liquids, or powders are to be measured).

11.2 Settings for Stability and Response

Generally, signal processing for greater stability slows the response and processing for higher response reduces stability. The AUW-D/AUW/AUX/AUY series are designed to have capability to provide both good response and high stability.

Most measurements can be done with the default settings, which is Standard mode. Depending on the environment and the objectives of using the balance, Anti-convection mode, High-stability mode and Pouring mode are also available. The currently set mode is easily checked by pressing the **[CAL]** key four times from mass display to produce the settings check display (see 7.4.1).

11.2.1 Standard mode

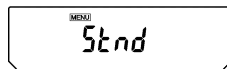

Settings Check Display

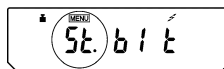

(When standard mode is selected)

This is the default setting. Use this mode unless stability or response is affected by environmental factors.

From the mass display, pressing the **[CAL]** key repeatedly until “Stnd” is displayed. Pressing the **[O/T]** key here sets the mode to Standard mode.

Setting of this mode can be confirmed only in settings check display (see 7.4.1).

11.2.2 Anti-convection mode



When ambient temperature changes (such as those due to air-conditioner cycling) are unavoidable during measurements, convection may occur in the weighing chamber and cause display fluctuation after the stability mark appears. The small range (minimum display of 0.01mg) of the AUW-D series is more likely to demonstrate this effect.

Settings Check Display

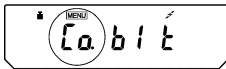

(When anti-convection mode is selected)

Anti-convection mode adjusts the timing of appearance of the stability mark. Note that when Anti-convection mode is selected, the stability mark will take longer to appear.

From the mass display, press the **[CAL]** key repeatedly until “ConvECT” is displayed. Pressing the **[O/T]** key here sets it to Anti-convection mode.

Setting of this mode can be confirmed only in settings check display (see 7.4.1).

11.2.3 High-stability Mode

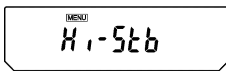

Settings Check Display

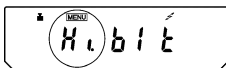

(When high-stability mode is selected)

The AUW-D/AUW/AUX/AUY series is designed to minimize the effects of vibrations or air currents. However, if it must be set up in a location with poor conditions, use this function to reduce the effects of vibration or air current even further. The response will slow slightly but the display will be stabilized.

From the mass display, press the **[CAL]** key repeatedly until “Hi-Stb” is displayed. Press the **[O/T]** key here to enter High-stability mode. Setting of this mode can be confirmed only in settings check display (see 7.4.1).

11.2.4 Pouring Mode (fast response)

When using the balance for dosing or filling a specified quantity, Pouring mode will give sufficiently fast response. Note that the display will become very sensitive and unstable.

Pouring mode allows adjustments to the surrounding environment, too. You can specify the environment of the installation site choosing from “normal environment”, “stable environment”, and “unstable environment”.

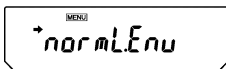

(when normal is selected)

Press the **[CAL]** key repeatedly from the mass display until “Pouring” appears.

Pressing the **[O/T]** key here sets it to Pouring mode and proceeds to “normL.Env” display. the arrow mark indicates that the displayed environmental setting is currently selected. Press **[POWER]** key to return to the mass display.

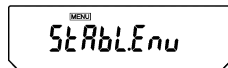

 A rectangular display showing the text "MENU" at the top and "StAbLEnv" below it.

 A rectangular display showing the text "MENU" at the top and "UnStbEnv" below it.

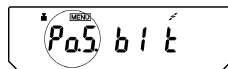
(when normal is selected)

 A rectangular display showing the text "MENU" at the top, "PoS" in a circle on the left, and "bit" on the right.

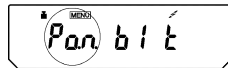
(Pouring mode for stable environmental condition)

 A rectangular display showing the text "MENU" at the top, "Pon" in a circle on the left, and "bit" on the right.

(Pouring mode for normal environmental condition)

 A rectangular display showing the text "MENU" at the top, "POU" in a circle on the left, and "bit" on the right.

(Pouring mode for unstable environmental condition)

Environmental setting menu

Or, press **[CAL]** key once or twice to display "StAbL.Env" (for very stable environmental condition) or "UnStb.Env" (for unstable environmental condition). Pressing **[O/T]** key at each display will select that environmental setting.

It is recommended to set "StAbL.Env" or "UnStb.Env" when you find the measurements are too slow or too unstable with the default "normL.Env".

Settings check display

Setting of Pouring mode can be confirmed only in the settings check display (see 7.4.1). Settings check display also shows the environmental setting for Pouring mode when this mode is selected.

11.3 Stability Detection Band

The appearance of the Stability Mark (➔) indicates that the mass display has been stabilized. The condition for judging stability is user-selectable. When the stability detection band is set to 1, the stability mark appears when the mass display stays within 1 count for a set period of time. The stability detection band setting may be selected from three levels: 1 count, 5 counts and 10 counts. The default setting is 1 count. One count is equal to 0.1mg when the minimum display is 0.1mg.

The setting of the stability detection band can be checked in the settings check display (see 7.4.1) by pressing the [CAL] key four times from mass display.

(Example)

(When setting is 1 count)

(Example)

(When setting is 1 count)

(Example)

(When set to 5 count)

(Example)

(When setting is 5 count)

Setting the Stability Detection Band

- 1 Press the [CAL] key repeatedly from the mass display. When “FUN.C.SEL” appears, press the [O/T] key. “CAL” is displayed.
- 2 Press the [CAL] key twice. “bAnd:**” is shown. The ** part (single or double digits) shows the current stability detection band setting.
- 3 Press the [O/T] key. “b-1” appears. At this point, pressing the [CAL] key changes the display in this order: “b-1”, “b-5”, “b-10” representing stability detection bands of 1 count, 5 counts, and 10 counts, respectively. When the current setting is displayed, the stability mark (➔) appears.
- 4 Press the [O/T] key to select the stability detection band currently displayed, or
- 5 Press the [POWER] key to return to the “bAnd:**” display without changing the setting.
- 6 Press the [POWER] key to return to the mass display.

11.4 Zero Tracking

Using the zero tracking function allows the display to be kept at the current zero point by automatically canceling slight drifts from the zero point caused by environmental conditions. When measuring very slow change in mass such as liquid droplets and evaporation processes, it is recommended to turn zero tracking OFF.

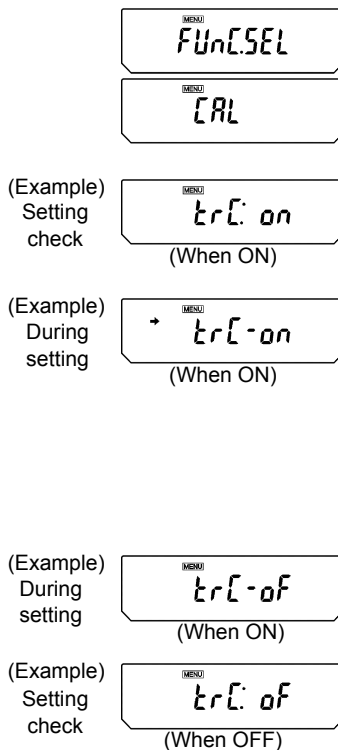

Setting zero tracking ON/OFF

- 1** Press the **[CAL]** key repeatedly from the mass display and when "FUnC.SEL" appears, press the **[O/T]** key to display "CAL".
- 2** Press the **[CAL]** key once. "trC:**" is shown. The ** part shows the current setting as "on" for on and "of" for off.
- 3** Press the **[O/T]** key. "trC-on" appears (The ":" changes to "-"). At this point, pressing the **[CAL]** key changes the display between "trC-of" (zero tracking off) and "trC-on" (zero tracking on). When the current setting is displayed, the stability mark (➔) appears.
- 4** Press the **[O/T]** key to select the zero tracking setting currently displayed, or
- 5** Press the **[POWER]** key to return to the "trC:**" display without changing the setting.
- 6** Press the **[POWER]** key to return to the mass display.

11.5 Stability Mark Lighting Timing

Stability Mark Lighting Timing can be selected according to use or demand accuracy.

When "Stability Mark Lighting Timing" is set to [FAST]	A Stability Mark lights up at the same time stability is detected. Although it becomes easy to change the measurement value after Stability Mark lighting, since many samples are measurable one after another, the increase in efficiency of working can be attained.
When "Stability Mark Lighting Timing" is set to [ACCURACY]	After stability is detected, when the stable state continues for fixed time, a Stability Mark lights up. Since judgment for lighting of a stability mark becomes severe and the measurement value after stability mark lighting is more stabilized, it is correctly measurable.

MENU
FuNC.SEL

MENU
CAL

MENU
Stb SiGn

Accuracy

MENU
+ACCURACY

Fast (Quick)

MENU
FAST

- 1** In the gram(g) display, press **[CAL]** key several times until **[FuNC.SEL]** is displayed.
Press **[O/T]** key.
[CAL] is displayed.
- 2** Press **[CAL]** key several times until **[Stb SiGn]** is displayed.
- 3** Press **[O/T]** key. **[ACCURACY]** is displayed.
Pressing **[CAL]** key alternately, the display **[ACCURACY]** or **[FAST]** changes to another.
[ACCURACY] means "Accuracy". **[FAST]** means "Fast (Quick)".
Stability mark **[→]** appears and means the displayed item has been set up now.
- 4** When item to be set up is displayed, press **[O/T]** key.
The item is set up and **[Stb SiGn]** is displayed.
- 5** Press **[POWER]** key twice to return to the gram(g) display.

12. Units

The AUW-D/AUW/AUX/AUY series allow display of various mass units. Units that are registered beforehand can be called by simply pressing the **[UNIT]** key when in mass display.

The default units are gram, percentage, PCS, and carat. In order to use the other units included in the AUW-D/AUW/AUX/AUY series, register the units beforehand according to section 12.1. Units that are not needed can also be removed from registration.

Registration of units for piece counting and specific gravity measurements are also covered in section 12.1. For information about piece counting, refer to 13.1. Refer to 13.2 for solid specific gravity measurement and 13.3 for liquid density measurement.

12.1 Setting Units of Measurement

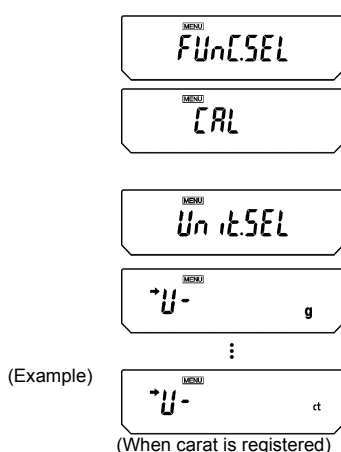

1 Press the **[CAL]** key repeatedly from the mass display until “FUnC.SEL” is showing. Press the **[O/T]** key to display “CAL”.

2 Press the **[CAL]** key repeatedly until “Unit.SEL” appears and press the **[O/T]** key. The display shows “U- g”.

At this point pressing the **[CAL]** key cycles the display in the order of the table below. The stability mark (➔) appears with the units and functions that are currently registered.

Menu display	Units or function	Reference
“U- g”	g (gram)	
“U- mg”	mg (milligram)**	
“U- %”	percentage conversion	See 12.2
“U- PCS”	piece counting	See 13.1
“U- ct”	ct (carat)	
“U- ,d”	solid specific gravity measurement	See 13.2
“U- d”	liquid density measurement	See 13.3
“U- mom”	monme*	
“U- Lb”	pound*	
“U- Oz”	ounce*	
“U- Ozt”	Troy ounce*	
“U- HK”	Hong Kong tael*	

(continued)

12. Units

"U- SporE"	Singapore tael*	
"U- tiwAn"	Taiwan tael*	
"U- ,mAL"	Malaysia tael*	
"U- ChinA"	Chinese tael*	
"U- dwt"	Pennyweight*	
"U- GN"	Grain*	
"U- m"	Mesghal*	
"U- b"	Baht*	
"U- t"	Tola*	
"U- o"	Parts Pound*	

* Depending on the legal restriction, these units are not always available.

* **Using a verified balance as a legal measuring instrument in the EU:**

These units are not available for use.

** **Using a verified balance as a legal measuring instrument in the EU:**

This unit is not available for use.

(Example)

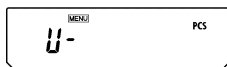

(When piece counting function is not registered)

3 Select the units to register by pressing the **[O/T]** key when the desired unit appears. To remove a registered unit, press the **[O/T]** key when the unit to be removed appears with stability mark.

A table of Unit Conversion Constants appears in Appendix A-5.

12.2 Percentage (%) Conversion

Setting a standard sample to 100% allows percentage conversions.

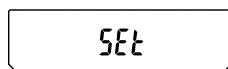
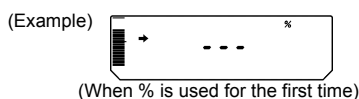
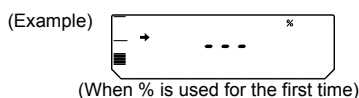
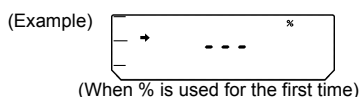

- 1** Register percentage unit beforehand. (See [12.1.](#)) Percentage unit is registered by default. Therefore, registration is not required if the default setting has not been changed.
- 2** From the mass display, press the **[UNIT]** key repeatedly to switch to the % display.
- 3** When a weighing vessel (container) is used, place the vessel on the pan and press the **[O/T]** key. (The display does not change.)
- 4** Load the item to serve as a standard (the item mass serves as 100% and must be at least 100 counts in gram display), and wait for the stability mark to appear.
- 5** Press the **[CAL]** key. After “SEt” is displayed, the mass of the standard item is set as 100%.
- 6** Remove the standard item and begin measurement by loading samples.
- 7** To return to the mass display, press the **[UNIT]** key several times.



Notes

- When the **[UNIT]** key is pressed, the display returns to the mass display, with units such as g. The actual mass of the current sample can easily be displayed at any time this way.
- When changing the item to serve as a 100% standard, the process must be repeated from step 3.
- In steps 2 through 4, the display is output in percentage based on the last setting of percentage conversion.

13. Application Functions

13.1 Piece Counting (PCS)

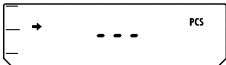
(Example) 
(When PCS is used for the first time)

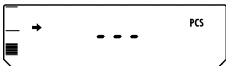
(Example) 
(When PCS is used for the first time)

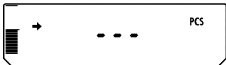
(Example) 
(When PCS is used for the first time)

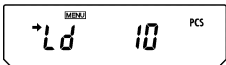

(Example) 
(When loading 20 pieces)

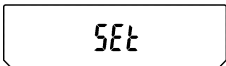

(Example) 

1 Register PCS as one of the units beforehand. (See 12.1.) PCS is registered by default. Therefore, registration is not required if the default setting has not been changed.

2 From the mass display, press the **[UNIT]** key repeatedly to switch to the PCS display.

3 When a weighing vessel (container) is used, place the vessel on the pan and press the **[O/T]** key. (The display does not change.)

4 Count the 10 pieces (or 20, 50, 100 pieces) of the sample to be measured accurately and load them on the balance.

5 Press the **[CAL]** key. "Ld 10" is displayed.

6 Every time the **[CAL]** key is pressed, the display will change in this order: "Ld 10", "Ld 20", "Ld 50", and "Ld 100".

7 When the correct number of pieces on the balance is displayed and the stability mark has appeared, press the **[O/T]** key.

8 "SEt" appears for several seconds and the number of pieces is displayed.

9 Load the items to be measured and read the number of pieces.



Notes

- When the **[UNIT]** key is pressed, the display returns to the mass display, with units such as g. The actual mass of the current sample can easily be displayed at any time this way.
- When changing the item to be counted, the process must be repeated from step 3.
- In steps 2 through 4, the display is output in pieces based on the unit mass of the item measured in the previous use of PCS.

13.2 Solid Specific Gravity Measurement

Solid specific gravity measurement computes the density (or specific gravity) of a solid sample by measuring its weight in air and in a liquid of known density (or specific gravity).

The following is the procedure when using a hanging pan, a tank and a table allowing below balance weighing, prepared by the operator. Measurement of density or specific gravity can be done even more easily with an optional specific gravity measurement kit. When using the kit, follow the instruction manual provided with the kit.

- 1** Remove the below-weigh hook cover on the base of the balance, after removing the two fixing screws.
- 2** Hang the user-prepared hanging pan from the below-weigh hook and sink that hanging pan into the liquid of the tank.
- 3** Register “,d” (the solid specific gravity) as a unit, referring to [12.1](#).
- 4** Input the density of the liquid to be used for solid specific gravity measurement.
 - (a) Press the **[CAL]** key repeatedly from the mass display until the “SEttinG” appears. Press the **[O/T]** key. The display shows “CAL dEF”.
 - (b) Press the **[CAL]** key repeatedly until “LSG SET” appears and press the **[O/T]** key. The **[MENU]** symbol and the # symbol appearing in the upper part of the display panel indicates it is numerical entry mode. Also “SG*.****” appears (where the *.**** is a number). The leftmost digit of *. **** blinks. The blinking digit can be changed.
 - (c) Press the **[UNIT]** key to increase the value of the blinking digit by 1. Press the **[PRINT]** key to set that digit and move the blinking digit one place to the right. When the desired setting is entered, press the **[O/T]** key to confirm the density of the liquid to be used, or
 - (d) Press the **[POWER]** key to abort the setting and return to the “LSG SET” display.

MENU
SEtt inG

MENU
CAL dEF

MENU
LSG SET

(Example) # MENU
SG 10000

(Example) # MENU
SG 10051

MENU
LSG SET

- (e) Select either the hold display mode or the continuous display mode for the specific gravity value display. Press the **[CAL]** key repeatedly until [SG Hold] appears.

Each time the **[O/T]** key is pressed the “→” symbol on the left side of the display turns on or turns off. The display is configured as shown below according to the on/off state of “→”.

→ on: Hold display mode

→ off: Continuous display mode (the specific gravity value is updated according to the change of weight in water)

- (f) Press the **[POWER]** key repeatedly to return to the mass display.

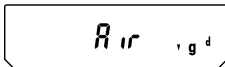

(Example)

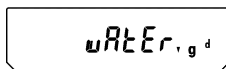

- 5** When the **[UNIT]** key is pressed a number of times from the mass display, [Air↕gd] appears for about two seconds. Afterward, the display switches to the [↕gd▶] display. This is the weight measurement in air mode. During weight measurement in air, “▶” turns on in the upper-right of the display.
- 6** Press the **[O/T]** key.
- 7** Place the items to be measured on the pan.
- 8** When the stability mark appears, press the **[CAL]** key. This measures the weight of the item being measured in air.
- 9** The display shows [wAtEr↕gd] for about two seconds. Afterward, the display switches to the [↕gd▶] display. This is the weight measurement in water mode. During weight measurement in water, “▶” turns on in the lower-right of the display.

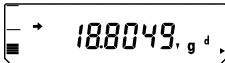
(Example) 

(Example) 

(Hold display mode example)

10 Place the items to be measured on the immersed hanging pan. The display shows the weight value in water. Press the **[CAL]** key to show the specific gravity value in the set specific gravity value display mode.

Press the **[POWER]** key to return to 9. If air bubbles adhered to the item being measured and the result is a specific gravity value that differs from the expected value, you can recalculate the specific gravity value by retrying the weight measurement in water after removing the air bubbles from the item.

11 To make the next measurement, unload the pans, press **[CAL]**, and begin again at Step 5. When finished measuring specific gravity, press the **[UNIT]** key.



Notes

- Although the density display shows 4 decimal places, not all of these digits will stabilize depending on the conditions.
- When the items to be measured are placed in the liquid, they must be completely immersed and must not have bubbles adhering to the surface of the sample or the immersed hanging pan.

13.3 Liquid Density Measurement

Liquid density measurement computes the density of a liquid by measuring the weight of a sinker (solid) with a known volume in air and in the liquid.

The following is the procedure when using a hanging pan, a tank and a table allowing below balance weighing, prepared by the operator. Measurement of density can be done even more easily with an optional specific gravity measurement kit. When using the kit, follow the instruction manual provided with the kit.

- 1** Remove the below-weigh hook cover on the base of the balance, after removing the two fixing screws.
- 2** Hang the user-prepared hanging pan from the below-weigh hook and sink that hanging pan into the sample liquid in the tank.
- 3** Register “d” (liquid density) as a unit, referring to 12.1.
- 4** Input the sinker volume (in cm^3) for liquid density measurement.
 - (a) Press the **[CAL]** key repeatedly from the mass display until the “SEtting” display appears. Press the **[O/T]** key. The display shows “CAL dEF”.
 - (b) Press the **[CAL]** key repeatedly until “Sv SEt” appears and press the **[O/T]** key. *.****” appears (where the *.**** is a number). The **[MENU]** symbol and the # symbol appearing in the upper part of the display panel indicates it is numerical entry mode. The leftmost digit of *. **** blinks. The blinking digit can be changed.
 - (c) Press the **[UNIT]** key to increase the value of the blinking digit by 1. Press the **[PRINT]** key to set that place and move the blinking digit one place to the right. When the desired setting is entered, press the **[O/T]** key to confirm sinker volume (in cm^3) of the sinker to be used, or
 - (d) Press the **[POWER]** key to abort the setting and return to the “Sv SEt” display.

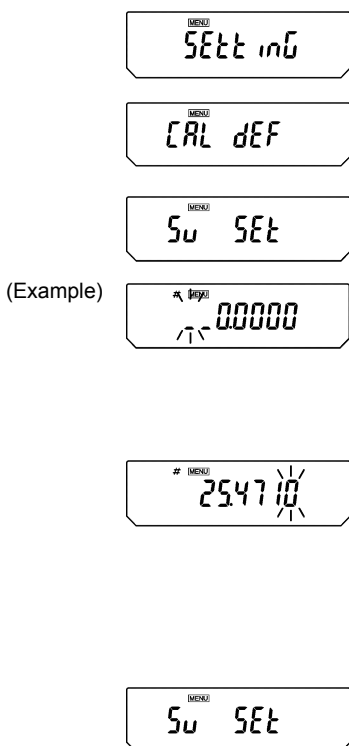

- (e) Select either the hold display mode or the continuous display mode for the specific gravity value display. Press the **[CAL]** key repeatedly until [SG Hold] appears.

Each time the **[O/T]** key is pressed the “**→**” symbol on the left side of the display turns on or turns off. The display is configured as shown below according to the on/off state of “**→**”.

→ on: Hold display mode

→ off: Continuous display mode (the specific gravity value is updated according to the change of weight in water)

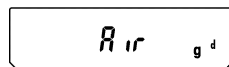

- (f) Press the **[POWER]** key again to return to the mass display.

- 5** When the **[UNIT]** key is pressed a number of times from the mass display, [Airgd] appears for about two seconds. Afterward, the display switches to the [gd▶] display. This is the sinker weight measurement in air mode. During weight measurements in air, “▶” turns on in the upper-right of the display.

- 6** Press the **[O/T]** key.

- 7** Place the sinker on the balance pan.

- 8** When the stability mark appears, press the **[CAL]** key. This measures the weight of the sinker in air.

- 9** [wAtEr gd] appears for about two seconds. Afterward, the display switches to the [gd▶] display. This is the sinker weight measurement in liquid mode. During weight measurements in liquid, “▶” turns on in the lower-right of the display.

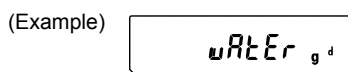
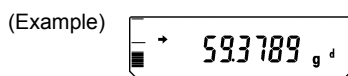

(Example)

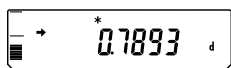

(Hold display mode example)

10 Place the sinker on the immersed hanging pan. The display shows the weight value in liquid. Press the **[CAL]** key to show the liquid density in the set specific gravity value display mode. Press the **[POWER]** key to return to 9. If air bubbles adhered to the sinker and the result is a density that differs from the expected value, you can recalculate the density by retrying the weight measurement in liquid.

11 To make the next measurement, unload the pans, press **[CAL]**, and begin again at Step 5.



Notes

- Although the density display shows 4 decimal places, not all of these digits will stabilize depending on the conditions.
- When the sinker is placed in the sample liquid, it must be completely immersed and must not have bubbles adhering to its surface or the immersed hanging pan.

13.4 Auto Print

Using Auto Print allows measurement results to be automatically output via the RS-232C connector or DATA I/O connector without pressing the **[PRINT]** key with every measurement. This function can be combined with WindowsDirect (see 6.). When Auto Print is activated, if a sample weighing 10 counts or more is placed on the pan while the mass displayed is within ± 5 counts of zero, the result is output via the RS-232C cable or DATA I/O connector automatically upon display stabilization.

Subsequent sample measurement results will output automatically, if the previous sample is first removed from the pan and the display returns to within ± 3 counts of zero.

(Example) 

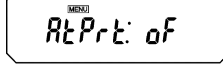

(Example) Setting check

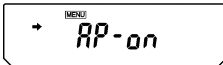
(When OFF)

(Example) During setting

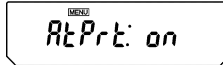
(When ON)

(Example) During setting

(When OFF)

(Example) Setting check

(When ON)



- 1** Press the **[CAL]** key repeatedly from the mass display until “FUnC.SEL” appears. Press the **[O/T]** key. The display will show “CAL”.
- 2** Press the **[CAL]** key repeatedly until “AtPrt:**” appears. the “**” shows the current setting, “on” for on and “oF” for off.
- 3** Press the **[O/T]** key. The display shows “AP-on” and after this, pressing the **[CAL]** key switches the displays between “AP-on” and “AP-oF”. When the current setting is displayed, the stability mark (\rightarrow) appears. To change the setting, press the **[O/T]** key when the desired setting appears, or
- 4** Press the **[POWER]** key to return to “AtPrt:**” without changing the setting.
- 5** Pressing the **[POWER]** key again returns to the mass display.
- 6** When the Auto Print mode is set up, the Auto Print symbol appears in the mass display.
- 7** To turn the Auto Print function off, follow steps 1 through 3, above.



Note

No more than one of the four application modes, Auto Print (13.4), Interval Timer (13.5), Add-on Mode (13.6), Formulation Mode (13.7), can be set ON at the same time.

13.5 Interval Timer (AUW-D/AUW/AUX series only)

Not applicable to a verified balance as a legal measuring instrument in the EU

This function automatically outputs the measurement values of the balance at set time intervals.

(Example)

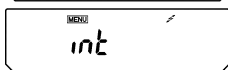
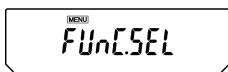

(Example)



(Example)

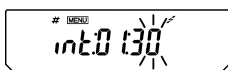

(When set to 1 minute, 30 seconds)

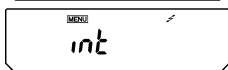
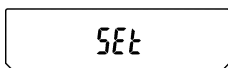

(Example)

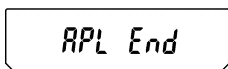

1 Press the **[CAL]** key repeatedly from the mass display until “FUNC.SEL” appears. Press the **[O/T]** key to display “CAL”.

2 Press the **[CAL]** key repeatedly until “int” appears.

3 Press the **[O/T]** key. “int: **:**” appears. (** are numbers)

The **[MENU]** symbol and the # symbol appear in order to show number entry mode. **: ** shows the current interval setting as [MM:SS] (where MM is minutes and SS is seconds). The leftmost digit blinks.

4 Pressing the **[UNIT]** key increases the blinking digit by 1. Pressing the **[PRINT]** key moves the blinking digit one place to the right. Set minutes up to 99 and seconds up to 59.

5 Press **[O/T]** key to set.

6 Press the **[POWER]** key repeatedly to return to the mass display. The letter “T” and STAND-BY symbol appear indicating interval output standby.

7 Press the **[PRINT]** key. Automatic output commences and continues at the set interval.

8 To pause, press the **[POWER]** key.

9 To discontinue the Interval Timer printing function, hold down the **[POWER]** key during mass display for about three seconds until “APL End” appears. The letter “T” and STAND-BY symbol will disappear.

**Note**

No more than one of the four application modes, Auto Print (13.4), Interval Timer (13.5), Add-on Mode (13.6), Formulation Mode (13.7), can be set ON at the same time.

**Notes**

- The **[O/T]** key can always be used for taring.
- In interval timer standby status, pressing the **[POWER]** key puts the balance in power standby status.
- Using the interval timer function for long periods of time may generate measurement errors due to drift of the balance.
- Short interval settings may not operate properly, depending on the capability of the device receiving the data. In this case, increase the length of the interval.
- During use of the interval timer function, keep PSC (10.3.2) and Clock-CAL (10.3.3) functions off.
- Do not perform any type of calibration while using interval timer function.

13.6 Add-on Mode

This function is convenient for making many measurements of minute samples. This function automatically output the measurement valve and tare after a sample is placed on the pan and the stability mark displays. Pressing the **[POWER]** key displays and output the total.

Setting

(Example)

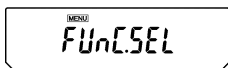

(Example)
Setting
check

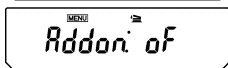

(When OFF)

(Example)
During
setting

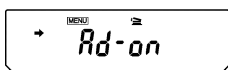

(When ON)

(Example)
During
setting

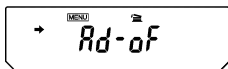

(When OFF)

(Example)
Setting
check

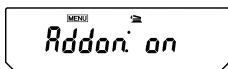

(When ON)



(Ready for start)

- 1** Press the **[CAL]** key repeatedly from the mass display until “FUnC.SEL” appears. Press the **[O/T]** key. The display will show “CAL”.
- 2** Press the **[CAL]** key repeatedly until “Addon:***” appears. The “***” shows the current setting, “on” for on, “oF” for off.
- 3** Press the **[O/T]** key. The display shows “Add-on” and after this, pressing the **[CAL]** key switches the displays between “Add-on” and “Add-on oF”. When the current setting is displayed, the stability mark (➔) appears. Press the **[O/T]** key when the desired setting is shown, to change the setting. When the Add-on Mode is set up. “--- ADDON MODE ---” is outputted.
- 4** Press the **[POWER]** key to return to “Addon:***”
- 5** Pressing the **[POWER]** key again returns to the mass display.
- 6** When the Add-on Mode is set up, the Add-on mode symbol and Standby mark appears in the mass display. It is ready for start.



Note

No more than one of the four application modes, Auto Print (13.4), Interval Timer (13.5), Add-on Mode (13.6), Formulation Mode (13.7), can be set ON at the same time.

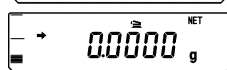
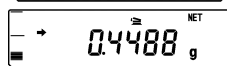
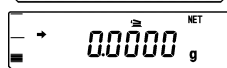
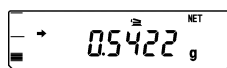
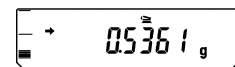

Operating Add-on Mode

When the Add-on Mode is set on and ready for start, the Add-on symbol and the Standby mark are illuminated in the mass display.

- 1** In the Add-on Mode, place the container (if used) on the pan and press **[O/T]** key to tare. (Taring is accepted when only ready for start.)
- 2** Pressing **[PRINT]** key starts measurement. Standby mark disappears. When GLP Mode ON, some items are outputted. (See 13.8.1)
- 3** Place the sample (first component) in the container. Upon stability, the mass value is outputted automatically with the numbering "CMP001". After output, the display is automatically tared.

The condition of this operation is as below.

- The displayed value is within ± 5 counts of zero in any unit before placing the sample.
 - The mass of sample is 10 counts or more.
- In the AUW/AUX/AUY series, when the minimum display digit has been eliminated by pressing the **[1d/10d]** key, the evaluation is based on the count number displayed before.

- 4** Repeat the above step 3 until all the component samples have been weighed.

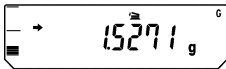

---ADDON MODE---	
CMP001 =	0,5361g
CMP002 =	0,5422g
CMP003 =	0,4488g
TOTAL =	1,5271g

Samples of output
 Decimal points can be
 either comma or period in
 the output. (Refer to 14.4)

5 Press the **[POWER]** key.

The measurements up to this point are summed up and displayed on the balance and outputted.

6 Clear the pan.

The balance is ready for the next set of measurements at before step 1.



Note

When Add-on mode is in use, fully-automatic span calibration by PSC (10.3.2) or Clock-CAL (10.3.3) is not performed. Instead, Weight symbol () keeps blinking when span calibration is necessary. Span calibration can be performed between sets of measurements.

13.7 Formulation Mode

This function is convenient for making many measurements of minute samples and seeking the total mass.

In this mode with any unit, when a sample is placed on the pan and **[PRINT]** key is pressed, that value is output via the RS-232C cable or DATA I/O connect and automatic taring is performed each time afterwards. This is repeated every subsequent time a new sample is placed and **[PRINT]** key is pressed. Pressing the **[POWER]** key stops the Formulation mode. When stopped, the measurements up to that point are summed up and displayed.

When the optional printer or computer is connected, the start up is printed out as “----- FORMULATION -----” and upon stop, the total is printed out as “TOTAL=”.

(Setting Formulation Mode)

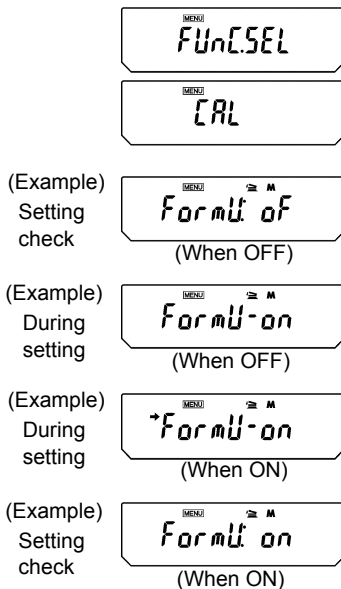

- 1** Press the **[CAL]** key repeatedly from the mass display until “FUnC.SEL” appears. Press the **[O/T]** key. The display will show “CAL”.
- 2** Press the **[CAL]** key repeatedly until “Formu:**” appears. The “**” shows the current setting, “on” for on, “oF” for off.
- 3** Press the **[O/T]** key. The display shows “Formu-on” and after this, pressing the **[CAL]** key switches the displays between “Formu-on” and “Formu-oF”. When the current setting is displayed, the stability mark (→) appears. Press the **[O/T]** key when the desired setting is shown, to change the setting, or
- 4** Press the **[POWER]** key to return to “Formu:**”.
- 5** Pressing the **[POWER]** key again returns to the mass display.



Note

No more than one of the four application modes, Auto Print (13.4), Interval Timer (13.5), Add-on Mode (13.6), Formulation Mode (13.7) can be set ON at the same time.

(Operating Formulation Mode)

When the Formulation Mode is set on, the add-on symbol and the Memory symbol are illuminated in the mass display.

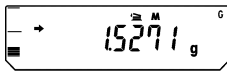
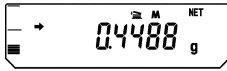
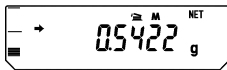
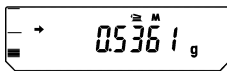

---Formulation Mode---	
CMP001 =	0,5361g
CMP002 =	0,5422g
CMP003 =	0,4488g
TOTAL =	1,5271g

The items above are outputted for the measurement examples shown here. Decimal points can be either comma or period in the output. (Refer to 14.4.)

1 In the Formulation Mode, place the container (if used) on the pan and press **[O/T]** key to tare. (Taring is accepted only before weighing the first sample.)

2 Place the sample (first component) in the container and press **[PRINT]** key.

Upon stability, the mass value is outputted to the external Device with the numbering "CMP001". After output, the display is automatically tared.

3 Repeat the above step 2 until all the component samples have been weighed.

4 Press the **[POWER]** key.

The measurements up to this point are summed up and displayed on the balance and outputted to the external device.

5 Clear the pan.

The balance is ready for the next set of measurements.



Note

When Formulation mode is in use, fully-automatic span calibration by PSC (10.3.2) or Clock-CAL (10.3.3) is not performed. Instead, Weight symbol () keeps blinking when span calibration is necessary. Span calibration can be performed between sets of measurements.

14. Communication with Peripheral Devices

14.1 Electronic Printer EP-80

The AUW-D/AUW/AUX/AUY series allows connection to Electronic Printer EP-80.

When using EP-80, follow these procedures for connecting to the balance.

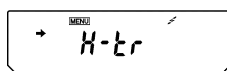
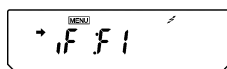

- 1** Set the communication status of the balance to F1 (standard settings 1). (See [14.3.2](#))
- 2** When using a computer as well, set to timer handshake (see [14.3.3.1](#)) in the user settings.
- 3** Turn off the power when the balance is either “oFF” or “STAND-BY”. Then connect the printer cable to the DATA I/O on the back of the balance. Connect the printer cable to the printer, too.
- 4** Turn on the balance power.
- 5** Turn on the printer power.



Notes

- Refer to the instruction manual of EP-80.
- Continuous output cannot be made to an electronic printer.
- Electronic Printer EP-60A can also be used.

14.2 Personal Computer - RS-232C

Programming with the command codes makes it possible to control the balance from a computer. When the balance does not have to be controlled by the computer, WindowsDirect (see 6.) offers very handy data transmission.

14.2.1 Connecting the Cable



Notes

- The cable must have the correct connections as shown in the diagram below.
- Cables with the connections shown below and the special accessory RS-232 cable are not guaranteed to operate properly for all types of computers and devices.
- Refer to 6.2.2 when using WindowsDirect function.

For DOS/V computers (D-sub9 pin) (Null-modem)

Computer side			Balance side	
RXD	2	-----	2	TXD
TXD	3	-----	3	RXD
DTR	4	-----	6	DSR
SG	5	-----	7	SG
DSR	6	-----	20	DTR
RTS	7	-----	5	CTS
CTS	8	-----	4	RTS
	9	-----	22This connection is not necessarily required.

14.2.2 Data Format

Data format 1 ("F-dF1" in menu item selection) is the Shimadzu's standard data format. (See [14.3.3.5](#)) The following is the details of this data format.

(1) Basic format

An example of data format for a negative weight value (-21.6865g) with delimiter of C/R is shown.

Data length of this example: 13 bytes													
Position	1	2	3	4	5	6	7	8	9	10	11	12	13
ASCII code	2DH	20H	20H	32H	31H	2EH	36H	38H	36H	35H	67H	20H	0DH
Data	-			2	1	.	6	8	6	5	g		C/R

The data length varies depending on attached information, unit expression and the delimiter selection as explained in (2).

Remarks

- Position 1: For a positive value, " " (space) (20H), and for a negative value, "-" (2DH) is in this position.
- Positions 2 to 10: The absolute value. When the numerical value does not use all the 9 positions, the code for space (20H) is entered to each excessive position as shown in this example.
With AUW-D, space may appear after the value; at the position No.10.
- Positions 11,12: One or two letters indicating the weighing unit. As shown in this example, the code for space is entered at position No.12 if only one letter is used for the unit.
- Position 13: Code for delimiter.

(2) Information of additional bytes

(i) **Output with stability information**

When outputting data with stability information (Refer to [14.2.3 D7](#)), the code for "S" or "U" is added before Position No.1 in the above example. Consequently, the data becomes 1 byte longer.

When stable: S

When unstable: U

(ii) **Verified balance as a legal measuring instrument**

The brackets "[]" bordering auxiliary indicating device of legal measuring instrument are also outputted. In this case, "[" and "]" are inserted to border the part of auxiliary indicating device in the format. Consequently, the data becomes 2 bytes longer.

14. Communication with Peripheral Devices

(iii) When the delimiter “C/R+L/F” is selected (Refer to [14.3.3.2](#))

The delimiter information requires one more character. Therefore one more byte is added after Position No.13 in the above example. Consequently, the data becomes 1 byte longer.

(3) Data format in case of “oL” or “-oL” (Overload)

The below is the data format for “oL”.

Data length of this example: 13 bytes													
Position	1	2	3	4	5	6	7	8	9	10	11	12	13
ASCII code	20H	20H	20H	20H	20H	4FH	4CH	20H	20H	20H	20H	20H	0DH
Data						O	L						C/R

For “-oL” (negative overload), Position 1 is replaced with “-” (minus, ASCII code: 2DH).

The following parts appearing in “(2) Information of additional bytes” also apply to (3).

(i) Output with stability information

(iv) When the delimiter “C/R+L/F” is selected

14.2.3 Command Codes



Caution

Inputting characters and command codes not shown here into the balance may not only alter the previous settings but may also impair proper measurement.

If by mistake characters or commands not shown here are entered into the balance, immediately unplug the power supply cable and wait about ten seconds before plugging it in again.

Command Code	Function	Description
D01	Continuous output	The balance continuously outputs every 110ms .
D05	1 time output	Corresponds to [PRINT] key
D06	Auto Print	See 13.4
D07	1 time output with stability information	The status of the stability mark is appended to the head of the data with output. S: when the stability mark is showing U: when the mark is not showing
D08	1 time output at stability	After command input, the data is output at the first appearance of the stability mark.
D09	Halt output	Auto Print and continuous output halted
Q	ON/OFF switching	Switches between standby status and measurement status.
T	Taring	Corresponds to the [O/T] key
TS	Taring after stability wait	After command input, taring is done at the first appearance of the stability mark.
C18	Span calibration	
M	Formulation mode measurement	See 13.7
+	Add-on mode measurement	See 13.6
R	Total reset	All application measurements terminated and reset
mg	mg unit registry*	See 12.
PERCENT	% unit registry	
PCS	Piece counting registry	
CT	ct unit registry	
MOM	Monme unit registry*	
SDENCE	Solid specific gravity registry	
LDENCE	Liquid specific gravity registry	
%	100% setting	

14. Communication with Peripheral Devices

Command Code	Function	Description
G	g, % switching	
- g	g unit removal	
- mg	mg unit removal*	
- PERCENT	% unit removal	
- PCS	Piece counting removal	
- CT	ct unit removal	
- MOM	Monme unit removal*	
- SDENCE	Solid specific gravity removal	
- LDENCE	Liquid specific gravity removal	
C02	High-stability mode setting	
C13	Anti-convection mode setting	
C14	Standard mode setting	
C05	Stability detection band, 1 count setting	
C06	Stability detection band, 5 count setting	
C15	Stability detection band, 10 count setting	
C07	Zero tracking	
C08	Unset zero tracking	
C10	Automatic span calibration	
C11	Unset automatic span calibration	
C17	Display setting status	Measurement conditions set by menu selection in abbreviated form is output.

* Not applicable to a verified balance as a legal measuring instrument in the EU.

14.3 Communication Settings

14.3.1 What are communication settings?

These settings are menu item selections for determining communication specifications when connecting to devices such as an electronic printer or a computer.

The settings here are effective for both RS-232C and DATA I/O communication specifications. When a printer or another device is connected to the DATA I/O connector, set the balance communication settings to "Standard Setting 1".

Five standard settings are stored in the balance, that are composed for frequently used types of communication. Selecting a standard setting allows all of these items to be set at once: communication speed (baud rate), delimiters, parity (and bit length), stop bit, data format, and handshake. Setting combinations that are not included in the standard settings may be selected by individual items in the User Settings.

14.3.2 Standard Setting

The combinations shown in the table below are available as standard setting 1 to standard setting 6. In the communication settings menu, the standard settings 5 and 6 cannot be selected. The standard settings 5 and 6 (WindowsDirect) can be set easily without entering the menu (see 6.2.1).

	Display at menu item selection	Compatible manufacturer	Baud rate	Delimiter	Parity (and bit length)	Stop bit	Data format	Handshake
Standard setting 1	iF:F1	Shimadzu (standard)	1200	C/R	None (8)	1	dF1	Hardware
Standard setting 2	iF:F2	Shimadzu (extended)	1200	C/R	None (8)	1	dF2	Hardware
Standard setting 3	iF:F3	Mettler	2400	C/R+L/F	Even (7)	1	dF3	Hardware
Standard setting 4	iF:F4	Sartorius	1200	C/R+L/F	Odd (7)	1	dF4	Hardware
Standard setting 5*	SETwin	Shimadzu WindowsDirect	300	Win	None (8)	1	dF1	Software
Standard setting 6*	SETwin -	Shimadzu WindowsDirect	300	Win -	None (8)	1	dF1	Software
User settings (see 14.3.3)	iF:USER		User set	User set	User set	User set	User set	User set

* Refer to 6.2.1 for selection of these standard settings.

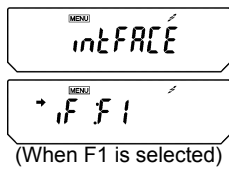
(Selecting one of standard Settings)

- 1** From the mass display, press the **[CAL]** key repeatedly until the [intFACE] display appears. Press the **[O/T]** key. The display shows “iF:F1”
- 2** If necessary, press the **[CAL]** key repeatedly until the desired standard setting display appears. Then, press the **[O/T]** key.
- 3** Press the **[POWER]** key repeatedly to return to the mass display.

14.3.3 User Setting

The user setting allows individual setting for each item in communication settings.

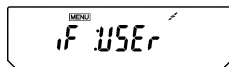
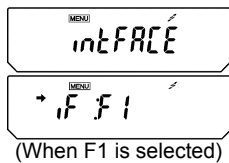
Making user settings

Displays of all the items

(Example)

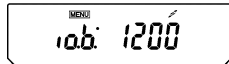

(Example)

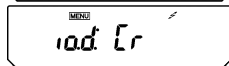

(Example)

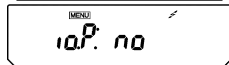

(Example)

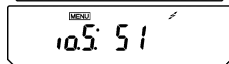

(Example)

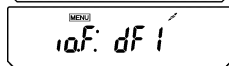

(Example)

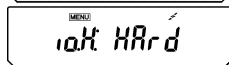

- 1** In mass display, press the **[CAL]** key repeatedly until “intFACE” appears and press the **[O/T]** key. “iF:F1” appears.
- 2** Press the **[CAL]** key repeatedly until “iF: USER” appears and press the **[O/T]** key. “io.b:****” appears (communication speed settings). (**** shows the current setting; 2 to 4 characters, the same applies hereafter.) After this, pressing the **[CAL]** key alternates the display in this order: “io.d:****” (delimiter setting), “io.P:*:**” (parity setting), “io.S:****” (stop bit setting), “io.F:****” (data format setting), and “io.H:****” (handshake setting).

- 3** When the item to be set appears, press the **[O/T]** key. (Refer to the following selections thereafter.)

14.3.3.1 Communication speed settings

- (1) The display changes from “io.b:****” to “b-300”. Pressing the **[CAL]** key cycles through the available settings. The stability mark (➡) appears, when the current setting is displayed.

Display during setting	b-300	b-600	b-1200	b-2400	b-4800
Setting specifics	300bps baud rate	600bps baud rate	1200bps baud rate	2400bps baud rate	4800bps baud rate
Display during setting	b-9600	b-19.2K	b-38.4K		
Setting specifics	9600bps baud rate	19.2Kbps baud rate	38.4Kbps baud rate		

- (2) When the desired setting appears, press the **[O/T]** key.
 (3) Press the **[POWER]** key to return to “io.b:****”.

14.3.3.2 Delimiter settings

- (1) The display changes from “io.d:****” to “d-Cr”. Pressing the **[CAL]** key cycles through the available settings. The stability mark (➡) appears, when the current setting is displayed.

Display during setting	d-Cr	d-LF	d-CrLF	d-Cn	d-win1	d-win-
Setting specifics	delimiter C/ R	delimiter L/ F	delimiter C/R + L/F	delimiter Comma	delimiter Windows- Direct (Enter)	delimiter Windows- Direct (Right)

- (2) When the desired setting appears, press the **[O/T]** key.
 (3) Press the **[POWER]** key to return to “io.d:****”.

14.3.3.3 Parity settings

The display changes from “io.P:****” to “P-no”. Pressing the **[CAL]** key cycles through the available settings. The stability mark (➡) appears, when the current setting is displayed.

Display during setting	P-no	P-odd	P-EvEn
Setting specifics	No parity (eight bits)	Odd parity (seven bits)	Even parity (seven bits)

- (1) When the desired setting appears, press the **[O/T]** key.
 (2) Press the **[POWER]** key to return to “io.P:****”.

14.3.3.4 Stop bit settings

- (1) The display changes from “io.S:****” to “S-S1”. Pressing the **[CAL]** key cycles through the available settings. The stability mark (➡) appears, when the current setting is displayed.

Display during setting	S-S1	S-S2
Setting specifics	Stop bit, 1 bit	Stop bit, 2bit

- (2) When the desired setting appears, press the **[O/T]** key.
 (3) Press the **[POWER]** key to return to “io.S:****”.

14.3.3.5 Input-output data format settings

- (1) The display changes from “io.F:****” to “F-dF1”. Pressing the **[CAL]** key cycles through the available settings. The stability mark (➡) appears, when the current setting is displayed.

Display during setting	F-dF1	F-dF2	F-dF3	F-dF4
Setting specifics	Data format 1. Standard Shimadzu format.	Data format 2. Extended format from data format 1.	Data format 3. Same format as Mettler balances.	Data format 4. Same format as Sartorius balances.

- (2) When the desired setting appears, press the **[O/T]** key.
 (3) Press the **[POWER]** key to return to “io.F:****”.



Caution

When using EP-80, EP-50, EP-50WIN or EP-60A electronic printer, always use data format 1.



Note

When set to data format 2, the balance will always send a process result in response to commands from the computer.

14.3.3.6 Handshake settings

- (1) The display changes from “io.H:****” to “H-oFF”. Pressing the **[CAL]** key cycles through the available settings. The stability mark (➡) appears, when the current setting is displayed.

Display during setting	H-oFF	H-Soft	H-HArD	H-tr
Setting specifics	No handshake	Software handshake	Hardware handshake	Timer handshake

- When the desired setting appears, press the **[O/T]** key.
 Press the **[POWER]** key to return to “io.H:****”.

14.4 Decimal Point Symbol in Output Data

The AUW-D/AUW/AUX/AUY series offers choice of decimal point symbols in the outputted data to a computer or an electronic printer. The decimal point can be expressed with either “.” (period) or “,” (comma) depending on your preference. Note that the decimal point expression on the balance display is always with “.” (period).

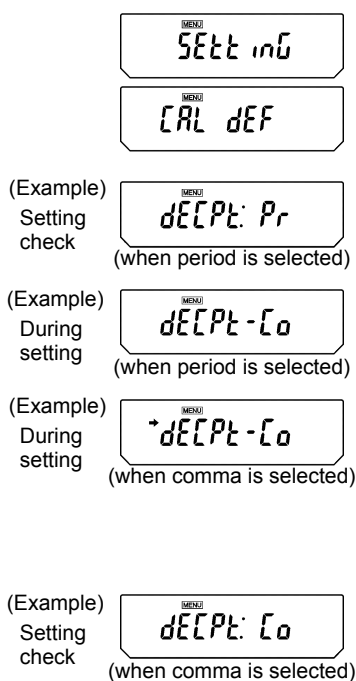

- 1** From the mass display, press the **[CAL]** key repeatedly until “SEtting” appears, press the **[O/T]** key. “CAL dEF” will appear.
- 2** Press the **[CAL]** key repeatedly until “dECPt:**” appears (** indicates the current setting. “Pr” for period, “Co” for comma).
- 3** Press the **[O/T]** key. The display shows “dECPt-Co” and after this, pressing the **[CAL]** key switches the displays between “dECPt-Co” and “dECPt-Pr”. When the current setting is displayed, the stability mark (➔) appears. To change the setting, press the **[O/T]** key when the desired setting appears, or
- 4** Press the **[POWER]** key to return to “dECPt:**” without changing the setting.
- 5** Pressing the **[POWER]** key again returns to the mass display.

15. Maintenance and Transport

15.1 Maintenance

Cleaning

Clean by wiping with a soft cloth soaked in neutral detergent and wrung tightly. The pan can be washed in water. Dry it thoroughly before attaching it to the balance. The side glass doors can be removed to allow cleaning and replacement of the door rail. Never use organic detergents and chemicals or chemical wiping cloths, as they may damage the coating and the display panel.



Caution

Handle the glass doors with great care to keep them from breaking. When removing the knob on the inside of the door, be very careful not to allow the hand to touch the pan supporter shaft in the weighing chamber. When removing the door rails, take care not to let the rail edge injure the hands.

When the glass door does not slide smoothly

- In the AUW-D/AUW/AUX/AUY series, the side glass doors can be removed to allow replacement and cleaning of the door rails.

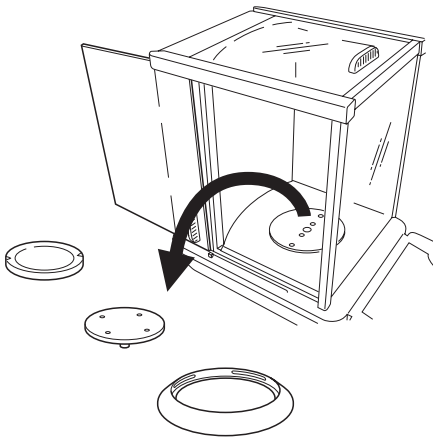

- 1** Remove the anti-draft ring, the pan, and the pan supporter from the weighing chamber

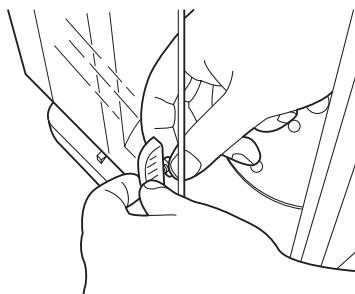

- 2** Unscrew and remove the inside knob on the glass door.

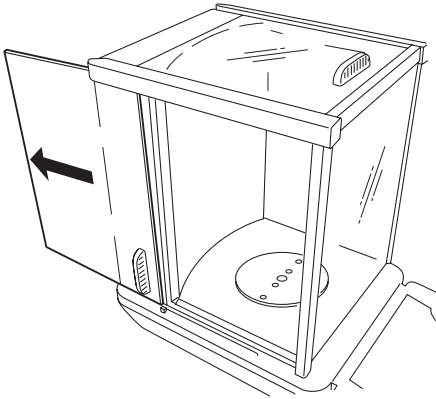

3 Slide the glass door out backwards.

- In the AUW-D/AUW/AUX/AUY series, when the door rails of the side glass doors become dirty or worn, the rails can be replaced.

Removing the door rail

1 Remove the glass door.

2 Press down the outer edge of the door rail with a pointed thing for lifting the door rail.

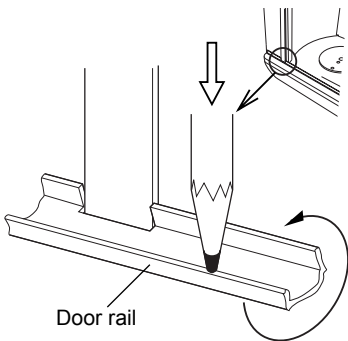

3 Lift and remove the rail.

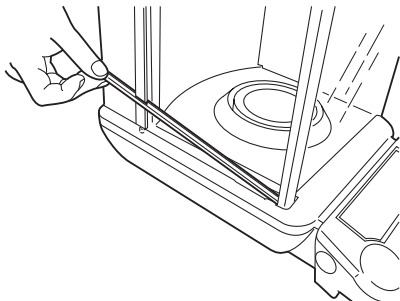

15.2 Transport

When moving by hand

... Remove the anti-draft ring, the pan, and the pan supporter from the weighing chamber. Lift the main body as shown in the figures and carry it securely in both hands.

When using other methods of transport

... Use the packing box in which the balance was delivered.

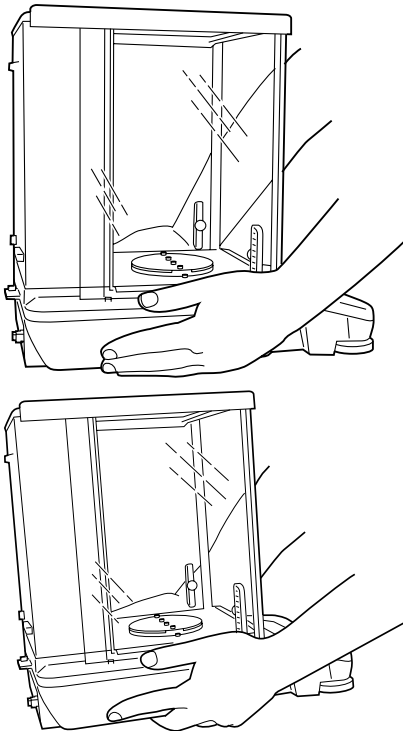

1 Place hands on the main body as shown in the figure.

2 Lift the main body slowly with the fingers inserted beneath the bottom of it.



Caution

This is a precision instrument. Handle with care and never give any impact.

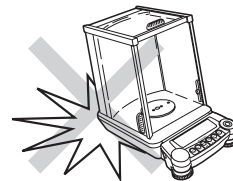

Note

Using a verified balance as a legal measuring instrument in the EU:

Span calibration must be newly performed (refer to [10.2](#)) after the balance has been moved and re-installed, before using the balance as a legal measuring instrument in the EU.

16. Troubleshooting

16.1 Error Code Displays

Error code display	Description	Countermeasures
CAL E2	The zero point shift is large during calibration.	Remove items from the pan. In order to postpone calibration, press [POWER] key.
CAL E3	Large span error in PCAL	Use the correct calibration weight.
CAL E4	Large span error in span calibration	Use the correct calibration weight.
CHE X (X is a numeral) (when the display stops here)	Internal malfunction	Please contact a service representative.
Err 0X (X is a numeral)	Internal malfunction	Please contact a service representative.
Err 20	An improper value setting was attempted.	Enter the correct numbers or decimal points.
Err 24	Power voltage error	Check the power voltage.

16.2 Troubleshooting

When	Symptom	Possible Causes	Countermeasures
Before measurement	Nothing appears in the display.	The AC adapter is not securely connected. The power switchboard of the room is turned off. The power voltage is incorrect.	Check power supply and connect correctly.
During measurement	The display fluctuates.	Vibration or wind effects	Change the installation site. Change the stability and response settings or change the stability detection band.
	The stability mark does not readily appear.	Attempting to measure volatile substances	Measure with a lid on it.
	The measured results have poor repeatability.	The weighed item is electrically charged.	Measure in a metal container. Measure with a metal object larger than the items.
	The display diverges in the same direction.	The sample temperature and the temperature inside the weighing chamber differ.	Measure at the same temperature. Leave the item in the chamber before measurement. Change to high-stability mode.
	"CAL d" appears frequently.	There are air currents entering the weighing chamber.	Leave the glass doors of the weighing chamber open 1 to 2 cm wide when not in use.
		Effects of electronic noise or strong electromagnetic waves	Move away from the noise source.
		Internal trouble with the balance	Contact a service representative.
	"oL" or "-oL" is displayed.	The load on the pan is too large. The pan is detached.	Use within the weighing capacity. Place the pan on correctly.
	Automatic span calibration executes frequently.	Severe temperature variations in the room or the instrument	Move to a location with less temperature fluctuation.
	The mass display is incorrect.	Span calibration has not been done.	Perform correct span calibration.
		No taring to zero before weighing.	Press the [O/T] key to return mass to zero before weighing.
	The desired weighing unit cannot be called by [UNIT] key.	The unit has not been registered beforehand.	Set unit beforehand. (See 12.1)
	Cannot transmit or receive data to or from computer or device.	Communication settings are wrong.	Make the proper communication settings.
Error message appears.		Refer to the error code table.	
During calibration	Error message appears.		Refer to the error code table.
Attempt of menu settings	The menu cannot be entered. "LoCKEd" is displayed briefly.	The menu is locked	Remove the menu lock. (See 7.4.3)

Appendices

A-1. Menu map

(→ in brackets after the menu item shows reference section number)

- **[CAL]** key: Pressing the **[CAL]** key moves to the next menu in the current hierarchy.
(↓ in the diagram below)
- **[O/T]** key: Pressing the **[O/T]** key moves the current hierarchy to the menu of one hierarchy down.
(→ in the diagram below) When no menu exists in the hierarchy below, this command is fixed.
- **[POWER]** key: Pressing the **[POWER]** key returns the current hierarchy to the menu of one hierarchy up.
(← in the diagram below) (Pressing the **[POWER]** key and holding it down returns the interface directly to the mass display.)

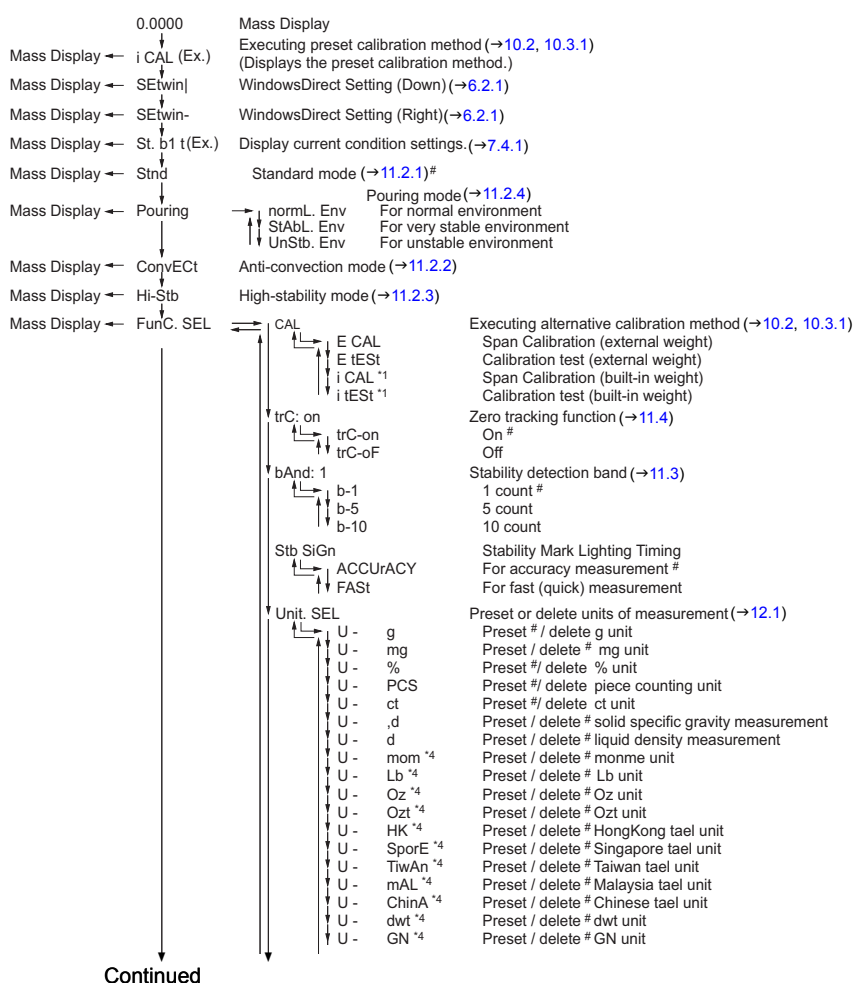

Continued

*1 AUW-D, AUW, AUX series only

*2 AUW series only

*3 AUW-D, AUW series only

Default settings

*4 These units cannot be selected in some countries for legal reason.

***4, *5 These units are not available in a verified balance as a legal measuring instrument in the EU.**

<p>Mass display ← SEtting</p>	<p>U - m^{*4} U - b^{*4} U - t^{*4} U - o^{*4}</p> <p>AtPrt: on ↓ Ap-on ↓ Ap-oF</p> <p>int^{*1.5} ↓</p> <p>AdiSP: on ↓ Ad-on ↓ Ad-oF</p> <p>Addon:on ↓ Adon-on ↓ Adon-oF</p> <p>FormU:on ↓ FormU-on ↓ FormU-oF</p> <p>CAL dEF ↓ E CAL ↓ E IES^t ↓ CAL^{*1} ↓ I IES^t^{*1}</p> <p>CAL SET ↓ PCAL.SET^{*1} ↓ PcAL^{*1}</p> <p>LigHt: on^{*2} ↓ LigHt-on^{*2} ↓ LigHt-oF^{*2}</p> <p>id: 1234</p> <p>GLP: on^{*1} ↓ GLP-on^{*1} ↓ GLP-oF^{*1}</p> <p>PSC: on^{*1} ↓ PSC-on^{*1} ↓ PSC-oF^{*1}</p> <p>tCAL: on^{*3} ↓ tCAL-on^{*3} ↓ tCAL-oF^{*3}</p> <p>tCAL t1^{*3} ↓ tCAL t2^{*3} ↓ tCAL t3^{*3}</p> <p>SG HoLd</p> <p>LSG SET ↓ Sv SET</p> <p>d-01.21^{*1} ↓ StYL.dATE^{*1} ↓ Y-m-d ↓ m-d-Y ↓ d-m-Y</p> <p>t-16:50^{*1}</p>	<p>Preset / delete # Mesghal unit Preset / delete # Baht unit Preset / delete # Tola unit Preset / delete # Parts pound unit</p> <p>Autoprint function (→13.4) On Off #</p> <p>Interval timer setting (→13.5)</p> <p>Bar graph display setting (→9.1) On# Off</p> <p>Add-on mode (→13.6) On Off #</p> <p>Formulation mode (→13.7) On Off #</p> <p>Selecting preset calibration method (→10.3.1) Setting span calibration by external weight # (AUW) Setting calibration test by external weight Setting span calibration by built-in weight # (AUW-D, AUW, AUX) Setting calibration test by built-in weight</p> <p>Input value of external weight for calibration (→10.3.5) Input value of external weight for built-in weight calibration (→10.3.6) Built-in weight calibration (→10.3.4)</p> <p>Backlight (→9.3) Backlight on # Backlight off</p> <p>Input balance ID number (→10.4.2)</p> <p>Calibration report (→10.4.1) Calibration report output on (GLP/GMP ISO compatible) Calibration report output off # (GLP/GMP ISO compatible)</p> <p>PSC (→10.3.2) PSC on # PSC off</p> <p>Clock-CAL (→10.3.3) Clock-CAL on Clock-CAL off #</p> <p>Clock-CAL running time setting (→10.3.3) Clock-CAL running time setting (→10.3.3) Clock-CAL running time setting (→10.3.3)</p> <p>Setting of display mode for specific gravity value Hold display # (→13.2, 13.3)</p> <p>Setting of solvent specific gravity for solid specific gravity measurement (→13.2) Setting of sinker volume for liquid density measurement (→13.3)</p> <p>Date setting (→8.1) Date output style (→8.2) YYYY-MM-DD # MM-DD-YYYY DD-MM-YYYY</p> <p>Time setting (→8.3)</p>
-------------------------------	---	--

Continued

*1 AUW-D, AUW, AUX series only
 *2 AUW series only (Not for AUW-D)
 *3 AUW-D, AUW series only
 # Default settings

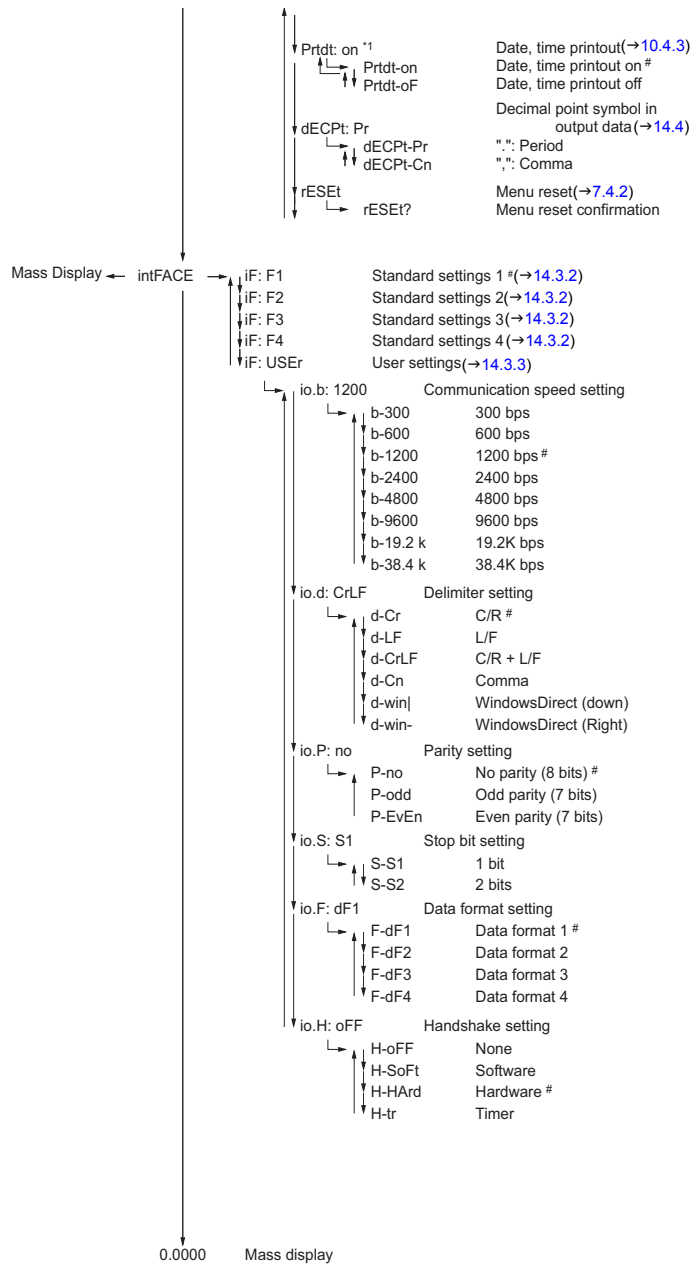

*1 AUW-D, AUW, AUX series only
 *2 AUW series only (Not for AUW-D)
 *3 AUW-D, AUW series only
 # Default settings

A-2. Standard Accessories and Maintenance Parts List

Part name	Part number	Remarks
Pan	321-41225	
Pan supporter assembly	321-62933	With rubber cushions
Anti-draft ring	321-62903	
AC adapter		Contact your distributor
Level screw	321-62884	
Glass door assembly (right)	321-62932-02	Includes handle
Glass door assembly (left)	321-62932-01	Includes handle
Glass door assembly (top)	321-62935	Includes handle
Front glass assembly	321-62931	
Door rail (right)	321-62901-01	
Door rail (left)	321-62901-02	
In-use protective cover	321-62936	
In-use protective cover (5pieces)	321-62982	
Rubber cushions (4pieces)	321-62984-02	For pan supporter
Knob for glass door (3pieces)	321-62985	
Adapter cable holder	072-60330-02	

A-3. Special Accessories (Options) List

Part name	Part number	Part number for RoHS	Remarks
Electronic Printer EP-80	321-62675-01 (w/o AC adapter)	321-80016-01 (w/o AC adapter)	Impact-dot print, Can be used with WindowsDirect, Statistical calculation.
Electronic Printer EP-90	321-62675-11 (w/o AC adapter)	321-80016-11 (w/o AC adapter)	Impact-dot print, Can be used with WindowsDirect, Statistical calculation, Sample No. can be attached, Date/time can be attached (except for AUJ)
RS-232C cable 25P-9P (1.5m)	321-60754-01		For IBM-PC/AT, DOS/V (Null modem)
Footswitch FSB-102TK	321-60110-12		For taring (corresponds to [O/T] key)
Footswitch FSB-102PK	321-60110-11		For output (corresponds to [PRINT] key)
Specific gravity measurement kit SMK-401	321-60550-01		
Application keyboard AKB-301	321-53382-01		UPPER, LOWER and TARGET keys for checkweighing cannot be used with AUJ-D/AUJ/AUX/AUJ series.

**Note**

The number and specifications noted here are subject to change without notice. The RS-232C cables are not guaranteed to match every computer or device. Also, their lock screws may not match the connector threads on the balance.

A-4. Specifications for RS-232C Connector

RS-232 Specifications

Pin number	Name	Function	Comment
1	FG	Frame ground	
2	TXD	Data output	
3	RXD	Data input	
4	RTS	Internal connection with CTS	
5	CTS	Internal connection with RTS	
6	DSR	Handshake reception	
7	SG	Signal ground	
8	NC	Open	
9	NC	Open	
10	NC	Open	
11	NC	Open	
12	NC	Open	
13	NC	Open	
14	NC	Open	
15	NC	Open	
16	NC	Open	
17	NC	Open	
18	NC	Open	
19	NC	Open	
20	DTR	Handshake (transmission)	
21	NC	Open	
22	NC	Open	
23	NC	Open	
24	NC	Open	
25	NC	Open	

A-5. Table of Unit Conversion Constants

The following conversions are used to display in various mass units.

1g	= 1000 mg
	= 5 ct
	= 0.266667 mom
	= 0.00220462 Lb
	= 0.0352740 Oz
	= 0.0321507 Ozt
	= 0.0267173 TL-HK
	= 0.0264555 TL-Singapore
	= 0.0266667 TL-Taiwan
	= 0.0264600 TL-Malaysia
	= 0.0266071 TL-China
	= 0.643015 dwt
	= 15.4324 GN
	= 0.216999 m
	= 0.0657895 b
	= 0.0857339 t
	= 1.12877 o



Note

Units except for “g” (gramme) and “ct” (carat) are not available for a verified balance as a legal measuring instrument in the EU.



Note

The unit of parts pounds (o) is not outputted to external devices.

A-6. Performance Check Guide

Not applicable to a verified balance as a legal measuring instrument in the EU



Notes

- The following is a standard guideline used to determine whether the balance is working properly. The specific criterion can be set according to each user's requirements.
- Conduct the performance check in a location without changes in room temperature. Install the balance following the instruction of this manual.
- Leave the calibration weight in the weighing chamber before start performance check so that the temperatures will be equalized.
- For placing and removing the weight, use a long pair of tweezers. Do not put hand into the weighing chamber.

Repeatability

For AUW-D series, perform steps 3 to 5 in both large and small ranges.

1 Leave the power on in mass display (backlight of AUW series illuminates if it is set to on) and let stand for one hour (two hours for AUW-D series).

2 Following chapter 11, set the stability and response to the standard mode, set the stability detection band to 1 count, and set zero tracking to OFF.

3 With a pair of tweezers, place a weight close to the weighing capacity on the pan and take it off six times. For each time record

X_i : the value displayed each time the weight is loaded

Y_i : the value shown when the weight is removed

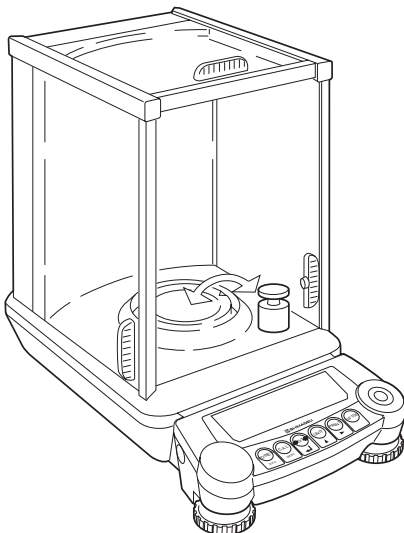

Load and unload a weight close to the capacity 6 times

Loaded: $X_1, X_2 \dots X_i \dots X_6$

Removed: $Y_1, Y_2 \dots Y_i \dots Y_6$

$R_x = X_{\max} - X_{\min}$

$R_y = Y_{\max} - Y_{\min}$

(Max is the maximum value. Min is the minimum value.)

4 Compute R_x and R_y according to the expressions given above.

5 R_x and R_y values within 1.0mg are normal.
(In the small range of AUW-D series, within 0.30mg.)

Cornerload Performance (four-corner error)

For AUW-D series, conduct this check in the large range.

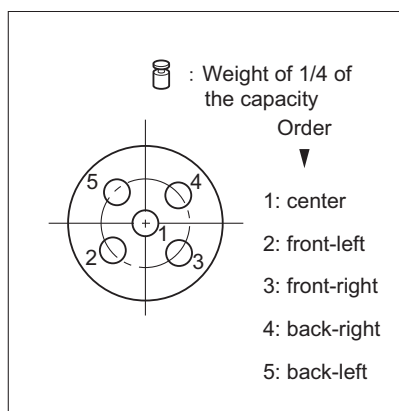

1 Warm up the balance thoroughly. Warm up for at least one hour.

2 Place a weight of about one-quarter of the capacity on the pan at the locations and in the order of the numbers given in the figure. Record the results X1 through X5, for the locations 1 through 5, respectively.

If all the differences between the value measured in the center location and each of the other locations are within $\pm 1\text{mg}$, the balance cornerload performance is considered normal.

(In AUW-D series, this check is not necessary in the small range.)

A-7. Below-weigh Hook Dimensions

(Unit: mm)

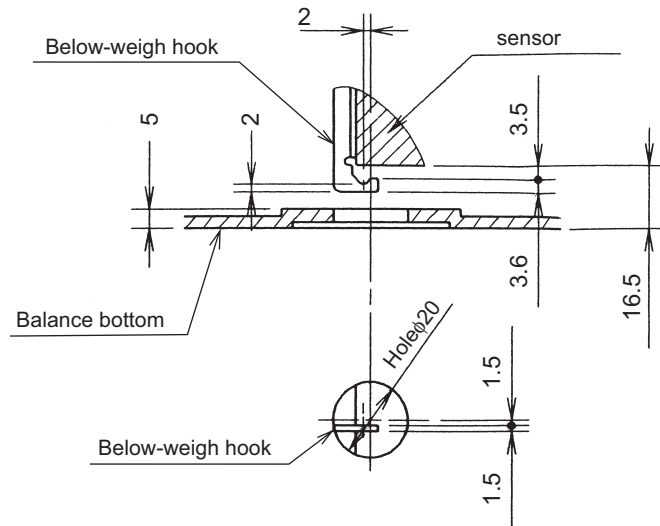

A-8. Index

A

AC adapter9, 12, 98
 accessories98
 add-on mode4, 74
 air currents55
 analog display → bar graph display
 anti-convection mode55
 anti-draft ring2, 9, 10, 90, 92, 98
 application functions64
 application keyboard98
 Auto Print20, 24, 71
 automatic output→Auto print, Interval timer

B

backlight12, 13, 37
 bar graph display4, 35
 basic operation15
 baud rate85, 87
 below-weigh hook2, 65, 68, 103
 BPS87
 built-in calibration weight → built-in weight
 built-in clock12, 32, 47, 54
 built-in weight40, 44, 45, 47, 49
 buzzer3

C

cable12, 21, 79, 80, 98
 calibration38, 39, 40, 44
 calibration of the built-in weight49
 calibration report47, 52
 calibration test44
 calibration test with built-in calibration weight
44
 calibration test with external weights44
 calibration weight value50, 51
 Clock-CAL13, 39, 47, 52
 command codes20, 83
 communication setting20, 85
 communication speed85, 86
 component names2
 computer20, 22, 79, 80, 85
 continuous output83

current time12, 34

D

data format81
 date32, 33, 54
 DC IN connector2, 12
 decimal point36, 89
 default settings20, 30, 95, 96, 97
 delimiter85, 87
 display2, 4, 11, 12, 35
 door → glass door
 dosing56
 dual range5, 17

E

electronic printer3, 52, 79, 85, 88
 environment settings55
 error code display93
 executing calibration40

F

filling56
 foot switch98
 format81, 85, 88
 Formulation mode77
 fully-automatic span calibration45, 47
 fully-automatic span calibration (based on temperature detection) → PSC
 fully-automatic span calibration (by time setting)
 → Clock-CAL

G

glass door2, 14, 15, 90, 91
 GLP52
 GMP52

H

handshake85, 88
 high-stability mode56

I

Inputting external calibration weight value ... 50, 51
 installation 7, 10, 38, 40
 interval timer 72
 in-use protective 11
 in-use protective cover 9, 11, 98
 ISO 52

K

key panel 2, 3, 11
 key switches → key panel

L

large range 17
 level adjustment 10
 level indicator 2, 10
 level screw 2, 10, 98
 liquid density 61, 68

M

maintenance 90, 98
 menu 27
 menu item selection 3, 27, 28
 menu lock 31
 menu map 27, 95
 menu reset 30
 minimum display 3, 5, 17, 36

N

numerical value input 3, 28

O

options 98
 output 3, 71, 72, 74, 83, 88

P

pan supporter 9, 10, 90, 98
 parity 85, 87
 PCAL → calibration of the built-in weight
 PCS 64

percentage 63
 performance check 101
 peripheral 79
 personal computer 80
 piece counting 64
 pouring mode 56
 power 12, 21, 79
 preset calibration method 44
 printer → electronic printer
 PSC 13, 45

R

range → weighing range
 response 55
 RS-232C 2, 21, 80, 99
 RS-232C connector (specification) → specifications for RS-232C connector

S

safety precaution III
 self check 12
 setting calibration type of regular use 44
 setting units 61
 settings check display 29, 30, 56
 small range 13, 15, 17
 solid specific gravity measurement 61, 65
 span calibration 13, 14, 38, 44, 45, 47, 49, 52
 span calibration with built-in calibration weight 44
 span calibration with external weights 14, 44
 specific gravity measurement kit 65, 68, 98
 specifications for RS-232C connector 99
 stability 55
 stability detection band 58
 stability mark 4, 15, 58
 Stability Mark Lighting Timing 60
 stability wait 83
 stand by 3, 4, 12
 standard accessories 98
 standard setting 85
 stop bit 85, 87

T

tare 3
 taring 2, 15

time34, 48
time interval72
transport92
troubleshooting25, 93, 94
types of calibration39

U

unit17, 61
unit conversion100
unit display17
Unpacking8
user settings85, 86

V

vibration 7, 13, 55, 56

W

warm up 12, 13, 15, 40, 45, 49, 102
warm-up 37
weighing chamber 2, 10, 15, 90
weighing range 3, 17
WindowsDirect 20, 71, 80

Z

zero tracking 59